

User Manual

Electric Heating Element

Návod na obsluhu — Topné těleso | Gebrauchsanweisung — Elektroheizpatrone |
Mode d'emploi — Kit résistance électrique | Manuale d'istruzioni — Elemento elettrico
riscaldante | Instrukcja Obsługi — Grzałka elektryczna | Инструкция по применению
— Электронагреватель | Návod na obsluhu — Elektrické vykurovacie teleso

MEG · DRY · MOA · MOA IR · REG 2 · REG 3

EN

CS

DE

FR

IT

PL

RU

SK

User Manual

Our products have been designed and manufactured in such a way to ensure that all quality, functionality and aesthetic requirements are met. We would like to congratulate you on the purchase of this great product and wish you a pleasant experience with it.

Electric radiator

Guide to safe installation and use.

1. Do not install the heater under an electrical socket point.
2. Your electric heater should be filled with a carefully measured amount of liquid. In the case of loss of heating medium, or in any other case which demands its supplementation, contact your supplier.
3. The device is not equipped with an external temperature controller *).

Do not use the device in a small room if unsupervised disabled or incapacitated individuals are inside it. Only use the device if those individuals are under constant supervision.

*) Does not apply to selected models. Ask your supplier for details.

4. Electric heater is not a toy. Children under the age of 3 should not be allowed within close proximity of the device without the supervision of an adult.

Children aged 3 to 8 should only be allowed to operate the heater when it has been properly installed and connected. The child must be under adult supervision or have been trained to safely operate the device while understanding the risks.

5. Note: Some parts of the radiator can be very hot and can cause burns. Pay special attention to the presence of children or people with disabilities.
6. If the device is used as a clothes and towel dryer, ensure that the fabrics drying on it have only been washed in water, avoiding contact with any harsh chemicals.
7. To ensure the safety of very small children, install the electric dryer so that the lowest tube is at least 600 mm above the floor.
8. The device should only be installed by a qualified installer in accordance with the applicable regulations regarding safety and all other regulations.
9. All installations to which the device is connected should comply with regulations applicable in the country of installation and use.
10. Extension leads or electric plug adapters should not be used in order to supply power to the heater.

11. While connecting the radiator to electric installation ensure that the circuit has a 30 mA residual-current circuit breaker and an appropriate over-current circuit breaker. With the permanent installation (cable connection without plug) it is also mandatory to provide an omnipolar cut-off switch with a minimum contact opening of 3 mm for disconnecting the device on all poles.
12. The device version labelled PB can be installed in bathrooms in zone 1, as defined by applicable law, subject to any additional regulations concerning electrical installations in wet areas.

Other versions of the device can be installed in Zone 2 or beyond.
13. The device is recommended for use solely as described in the manual.
14. Ensure that the heater has been installed on a wall in accordance with its installation manual.
15. Please forward this instruction manual to the end user.

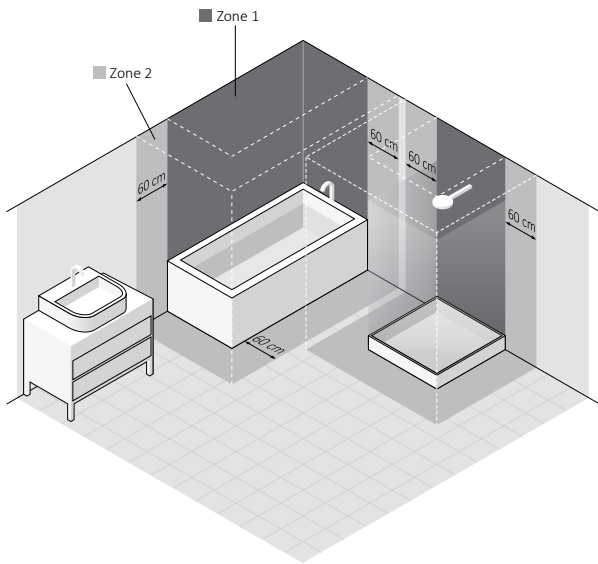
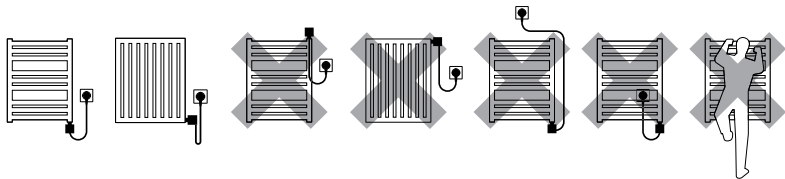

Electric Heating Element

Safety requirements — installation

1. Fitting and connection of the heating element should only be performed by a qualified installer.
2. Connect the unit to a sound electrical installation (see the ratings on the heater).
3. Switching on the heating element in the open air to test the device is permitted for a maximum of 3 seconds.
4. Never test a heating element that is already installed. Do not turn the heating element on in an empty radiator!
5. Ensure that the power cord does not touch the hot parts of the heating element or radiator.
6. Before installing or removing the device, make sure it is disconnected from the power source.
7. Do not open the device — any interference with internal components will invalidate the warranty.
8. The heating element's power output must not exceed the radiator's power output for the parameters 75/65/20°C.

9. The pressure in the radiator should not exceed 10 atm. Ensure that an air cushion is preserved in electric radiators. In central heating systems, leave one valve open to prevent pressure build up due to the thermal expansion of the liquid.
10. The device is intended for home use only.
11. Fitting and Installation of the device must be carried out in accordance with all local regulations for electrical safety, including installation within permissible locations only. Observe bathroom electrical zone regulations.

Safety requirements — use

1. The heating element must be fully submerged in the heating liquid during its operation.
2. Regularly check the device for damage to ensure it is safe to use.
3. If the power cord is damaged the device should not be used. Unplug the device and contact the manufacturer or distributor.
4. Do not allow flooding into the heating element casing.
5. Do not use the heating element in heating systems where the water temperature exceeds 82°C.

6. The heating element and radiator can heat up to high temperatures. Please be cautious — avoid direct contact with the hot parts of the equipment.
7. Do not open the heating element casing.
8. In the central heating system, always make sure that one valve of the radiator remains open.
9. Ensure that minors aged 8 and above or those with a physical or mental disability are supervised if operating the device.
10. The device is not a toy. Keep it out of the reach of children.
11. The device must be disconnected from the mains during cleaning and maintenance.
12. Cleaning of the equipment by children under 8 years of age is only permitted under appropriate supervision.

Intended use of device

The heating element is an electric device intended solely for installation in radiators (standalone or connected to the central heating system).

Heating element power output should be matched with radiator output for parameters of 75/65/20° C

Technical information

Model markings (power cable type):	PB (Straight cable without plug) * PW (Straight cable with plug) SW (Spiral cable with plug)																		
Type of electrical connection:	Y: MEG, MOA, MOA IR, REG 3, DRY Z: REG 2																		
Heat outputs available:	120, 200, 300, 400, 600, 800, 1000, 1200 [W]																		
Power supply:	230 V / 50 Hz																		
Insulation class:	Class I																		
Towel rail connection thread:	G 1/2"																		
Casing protection class [IP]:	IPx4: MEG IPx5: REG 2, REG 3, MOA, MOA IR, DRY																		
Length of heating element:	<table border="1"><tr><td>120</td><td>200</td><td>300</td><td>400</td><td>600</td><td>800</td><td>1000</td><td>1200</td><td>[W]</td></tr><tr><td>315</td><td>275</td><td>300</td><td>335</td><td>365</td><td>475</td><td>565</td><td>660</td><td>[mm]</td></tr></table>	120	200	300	400	600	800	1000	1200	[W]	315	275	300	335	365	475	565	660	[mm]
120	200	300	400	600	800	1000	1200	[W]											
315	275	300	335	365	475	565	660	[mm]											

* Device intended to be connected permanently to the system

Installation or removal

Detailed information demonstrating the different ways of installing or removing a radiator heating element is available from the manufacturer or importer (see footnotes at the end of the manual). Below we list some basic requirements and principles which must be followed to ensure long term, reliable operation of the product.

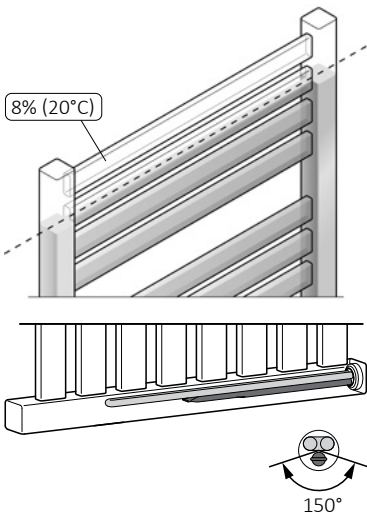

When installing the heating element horizontally, the single tube (capillary) where the temperature sensor is located, should be positioned to be as close to the bottom of the radiator as possible.

Before installation or first use:

1. Read the chapter *Safety requirements —Installation*.
2. Fit the heating element using the correct spanner (size  22).
3. The heating element must be installed at the bottom of the radiator, perpendicular to the radiator pipes, while preserving space for the proper circulation of the heating medium.
4. Use a suitable heating medium for filling the electric radiator, i.e. (water, special products based on water and glycol for use in central heating systems, or oil which complies with the requirements of the manufacturer of the radiator and heating element).
5. Do not switch the heating element on if it is not fully immersed in radiator heating medium.
6. Make sure an adequate air cushion is present to protect against excessive pressure build up within the heater (always leave one of the radiator valves open).
7. When filling the radiator with hot liquid insure that the liquid temperature does not exceed 65° C.

8. Follow the subsequent guidelines when connecting the electrical installation:
 - a. Brown wire — live connection to the circuit (L).
 - b. Blue wire — connect to neutral (N)
 - c. Yellow & green wire — earth connection (PE).
 9. Before filling the radiator with heating medium, ensure that the heating element is fitted properly and that it is water tight.
 10. In central heating installation radiator must be fitted with the valves enabling disconnection of the radiator from the rest of the system.
 11. The temperature of the heating agent in the central heating system must not exceed 82°C!
 12. For detailed installation hints — see the last pages of this manual.
3. Before disassembly, close the appropriate valves and drain the radiator completely to avoid causing any damage.

Product disposal



This product should not be disposed of as general waste but should be brought to the appropriate collection point for re-cycling of electric and electronic devices. This information is provided by the sign on the product, user manual and packaging. Information on the appropriate point for used devices can be provided by your local authority, product distributor or the store from where the product was purchased. Thank you for your effort towards protecting the environment.

Maintenance

- Before performing maintenance, always unplug the unit from the mains system.
- Periodically check the fluid level in the radiator and ensure the heating element is completely submerged.
- Clean the product with a dry or damp cloth. If necessary, use a very small amount of detergent, ensuring that it contains no solvents or abrasives.

Notes prior to removal:

1. Before dismantling permanently, disconnect the heating element from the mains and ensure that the radiator is not hot.
2. Be aware. A radiator filled with liquid can be very heavy. When moving the radiator, ensure that you take the necessary safety precautions.

MEG

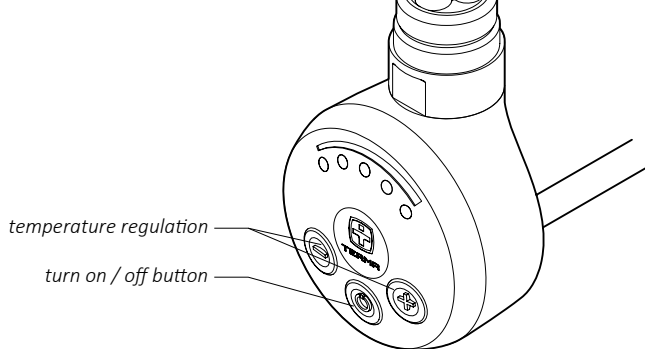

Turning on the device will result in the heating of the radiator up to the set temperature. After reaching the set temperature the device will turn off and on regularly in order to maintain the set temperature.

The construction of the device as well as the physical characteristics of the heating agent inside the radiator influence the way in which the heat is distributed — the temperature of the bottom pipes on the radiator (especially the two located at the very bottom of the radiator) may be lower than the temperature of the remaining parts of the radiator — this is normal.

Temperature increase

In order to increase the temperature of the radiator, press ⊕ once or several times as required; the right number of diodes will start blinking. The last blinking diode indicates the set temperature, whilst the last.

Temperature decrease

In order to decrease the temperature of the radiator, press ⊖ once or several times as required; the right number of diodes will start blinking. The last diode that which shines constantly indicates the set temperature whilst the last blinking diode indicates the current temperature. The following diodes will start fading on reaching subsequent temperature levels.

Anti-freeze function (anti-freeze protection)

When the device is off and the temperature around temperature sensor drops down below 6°C, the device will switch on automatically. This is to prevent the heating agent inside the radiator from freezing. Activating Anti-freeze mode is indicated by winking of the middle diode.

Problem solving

Problem	Possible cause	Solution
The device is plugged in, no diodes are on.	Problem with the connection.	Check the connection of the power wire, the plug and the socket.
Heating element is not heating, outside diodes are winking alternately.	Temperature sensor has been damaged.	Disconnect the device completely, wait until the radiator cools down and then re-connect it.
	Overheating of device.	Check and confirm that the heating element's output does not exceed the recommended output of your radiator. Check and reduce the water temperature in the central heating system - must not exceed 82°. In electric-only version check, if the radiator is properly filled with the heating agent.
Heating element is heating despite turning it off with the on/off button.	Damaged Electronics.	Disconnect the device completely, wait until the radiator cools down and then re-connect it.
If the problem continues please contact Your local Distributor.		

DRY

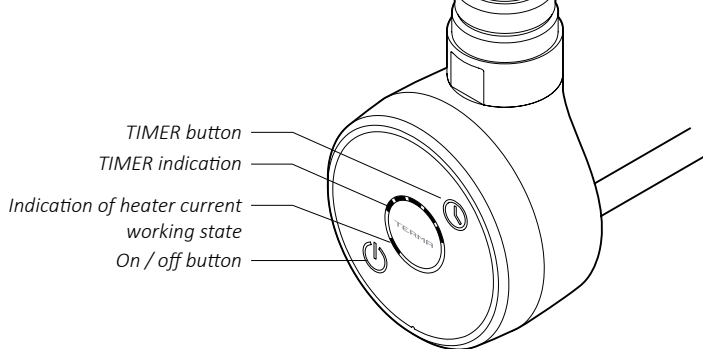

Functions

Heater DRY has 1 fixed temperature setting (default temperature of 48° C) and an advanced range of automatic switch off functions after 1-5 hours. This makes the product convenient and user-friendly — perfect for drying clothing and towels. The default heating temperature for the towel rail can be set to any of the following values: 43, 48, 52, 55 or 60° C. A built-in temperature sensor protects the towel rail from freezing in situations where the temperature falls below 5-7° C. The LED diode next to the on/off button will flash recurrently, indicating that the anti-freeze protection is active.

Heater use

The heater is turned on by pressing the on/off button. The LED diode at the on/off button lights up when the heater is on and the regulator maintains the set heating temperature. Attention: the heater control panel turns the device on only when radiator temperature is lower than the set temperature (default temperature of 48° C). On reaching the required temperature, the heater will turn on recurrently to maintain the set temperature only. This function allows much lower energy consumption than calculations based on the heaters nominal heat output might indicate. In the upper left part of the control panel, there is a (TIMER) button which can be used to set the automatic switch off time of the device. Every subsequent pressing of the buttons will light up diodes on the heat-

ing time indicator and allow the user to pre-set the “switch off” time of the device to between 1 and 5 hours from the current time.

After this time, the heater will turn off automatically.

It is useful to know that:

- Longer pressing of the **⊖** button will automatically set the timer to 5 hours or, turn off the TIMER function,
- The **⊖** button can also be used when the heater is off. On pressing the button, the heater will automatically turn on and set the TIMER to 1 hour,
- If you want to turn the TIMER off, press the **⊖** button several times or simply turn the heater off and on,
- TIMER LED diodes will turn off one by one, to display the correct, remaining drying time.

The construction of the heater as well as physical characteristics of various heating liquids may cause an uneven heat distribution inside the towel rail. As a result, bottom pipes of the towel rail may stay cool. Such phenomenon is completely normal and is not an indication of heater failure.

Modification of radiator heating temperature

The default temperature of the heater is 48°C. The user can modify the heating temperature by following these steps:

1. Disconnect the device from the electricity supply (i.e. unplug the device).
2. Press and hold the on/off button while reconnecting the heater to the electricity supply.
3. Release the button.
4. One of 5 TIMER diodes will start flashing. Select the required temperature value by pressing the button until the corresponding diode starts flashing. Temperature values for each diode are shown in the table below:

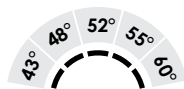

5. Wait for 10 seconds or press the TIMER button in order to confirm your chosen value.

Device malfunction alert

DRY Heater has built-in malfunction monitoring and alert functions.

Device malfunction is signalled in the following way: the two outer diodes shine with constant light while the middle diode flashes in the following manner — several flashes followed by a longer break. The number of diode flashes indicates an error code as described below:

- a) “Running in dry conditions” (error code: 2 flashes) — electronic system identified a situation indicating too little heating liquid inside the towel rail. Check to see if the towel rail has been properly filled with heating medium.
- b) “Overheating” (error code: 3 flashes) — the temperature of heating liquid inside the towel rail is too high
 - If the heater heats up despite being turned off, it is likely that the electronics have been damaged. The heater should be returned to the supplier/manufacturer for repair.
 - If the heater is installed inside a towel rail that is connected to a central heating system with hot water in the system, an alert does not mean that the heater has been damaged. The alert signals that temperature of the

installation is too high. Please ensure that temperature of the water inside the installation does not exceed 82°C as this could cause damage to the heater’s thermal fuse.

- c) “Temperature sensor damaged” (error code: 4 flashes) — There is a possibility of electronic system malfunction. The heater will most likely need repair.
- d) “Warning against possible heat escape into the system in central heating installations” (error code: 5 flashes) — there is a risk of a heat escape into the system if device is operating with the central heating system on and system water in circulation.

Attention: when closing the central heating installation valves, ensure that 1 valve remains open. This will prevent pressure in the towel rail from rising excessively.

The malfunction alert may be removed by turning the heater off and on again.

In the case of a malfunction alert, turn the heater off and wait for the towel rail to cool down. Check the device for a possible cause (referring to the manufacturer “problem solving” guide) and try to resolve it. If the heater is still signalling malfunction after it is turned on again, you should contact your supplier or, alternatively, the product manufacturer.

Problem solving

Problem	Possible cause	Problem solution
The heater is signalling malfunction alert (outer diodes shine constantly, while the middle one pulsates).	See description of malfunctions alerts.	Follow the steps specified in the paragraph relating to “Device malfunction alerts”.
Radiator is completely cold, diodes shine correctly.	The thermal fuse has been damaged — an electronics failure.	The device must be returned for repair.
Heater is off, it cannot be turned on. Diodes do not work.	No power supply. Electronics failure.	Check that the heater is correctly connected. If the connection is correct, the product must be returned for repair.
Device heats without control, it cannot be turned off.	Electronics damage.	Product requires repair at an authorized repair point.
Turning the heater on causes the electrical installation’s safety devices to activate.	Mechanical damage to device resulting from excessive pressure inside the radiator (i.e. no air cushion).	Product requires repair at an authorized repair point.
	Damage of electric isolation of the heating element or other damage.	Please contact an electrician in order to verify the source of the problem. Alternatively, contact an authorized service point.

MOA

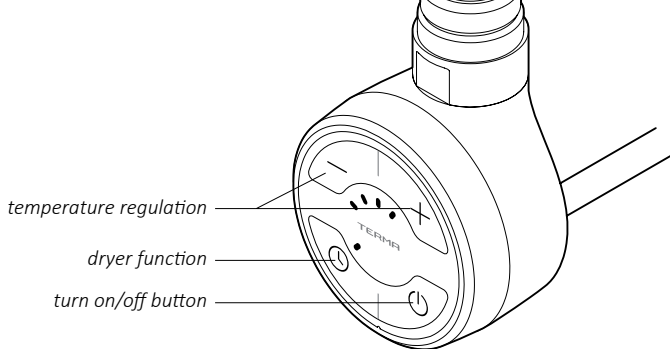

Turning the device on with the $\text{\textcircled{O}}$ button will result in the radiator heating up to the set temperature. After reaching the set temperature the device will turn off and on regularly in order to maintain the set temperature.

The construction of the device as well as the physical characteristics of the heating agent inside the radiator, influence the way in which the heat is distributed — the temperature of the bottom pipes on the radiator (especially the two located at the very bottom of the radiator), may be lower than the temperature of the remaining parts of the radiator — this is a normal phenomenon.

Temperature increase

In order to increase the temperature of the radiator, press $\text{\textcircled{+}}$ once or several times as required; the correct number of diodes will start blinking. The last blinking diode indicates the set temperature, whilst the last di-

ode which shines constantly, indicates the current temperature. The remaining diodes will start shining constantly on reaching subsequent temperature levels.

Temperature decrease

In order to decrease the temperature of the radiator, press $\text{\textcircled{-}}$ once or several times as required; the correct number of diodes will start blinking. The last diode, which shines continuously, indicates the set temperature whilst the last blinking diode indicates the current temperature. The remaining diodes will start fading on reaching subsequent temperature levels.

Anti-freeze function

When the device is off and the temperature surrounding the temperature sensor drops to below 6°C , the device will switch on au-

tomatically. This is to prevent the heating agent inside the radiator from freezing. The activation of Anti-freeze mode is indicated by the blinking of the middle diode.

Dryer function

The Dryer turns the device on for 2 hours, e.g. in order to dry a towel. After this period of time the device automatically switches to the mode to which it was set before the dryer mode.

Dryer function can be activated during heater operation by pressing **⊕** button. You can now freely adjust desired temperature level (buttons **⊕** and **⊖**). After 2 hrs heater will revert to the previous setting (before dryer function activation). To use 2 hrs timer heating element must be switched off. Switch it on by pressing **⊕** button. After 2 hrs heater will switch off automatically.

Press **⊕** button at any time to interrupt the dryer mode.

Calibrating the temperature span

The standard temperature span of the heating element is 30-60°C. It is possible to increase or decrease that span by setting a maximum temperature of between 45°C and 65°C, (minimum temperature of 30°C stays unchanged). This allows the user to

achieve a maximum temperature which is higher than the standard or to effectively heat a space with the device during lower surrounding temperatures.

Example: for the temperature regulation span of up to 45°C (30-45°C) modification by one step (one diode), means increase/decrease of temperature by 3.75°C, while for the temperature regulation span of up to 65°C (30-65°C) modification by one step means increase/decrease by 8.75°C.

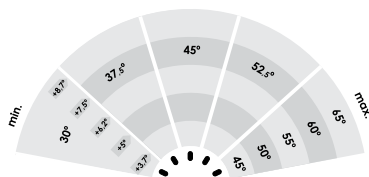

In order to modify the temperature span, unplug the device and plug it back in, while pressing **⊕** button. A single diode will start blinking on the display panel. Use **⊕** and **⊖** buttons to set one of the 5 possible maximum temperatures. The first diode stands for 45°C. The following diodes refer to the following maximum temperatures: 50°C, 55°C, 60°C and 65°C.

After selecting the new temperature span press on/off button to store the new settings.

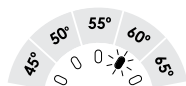

Problem solving

Problem	Possible cause	Solution
The device is plugged in, no diodes are on.	Problem with the connection.	Check the connection of the power wire, the plug and the socket.
Heating element is not heating, outside diodes are blinking alternately.	Temperature sensor has been damaged.	Disconnect the device completely, wait until the radiator cools down and re-connect it again.
	Overheating of device.	Check and confirm that the heating element's output does not exceed the recommended output of your radiator. Check and reduce the water temperature in the central heating system—must not exceed 82°. In electric-only version check, if the radiator is properly filled with the heating agent.
The device is heating despite turning it off with the  button.	Damaged electronics.	Disconnect the device completely, wait until the radiator cools down and re-connect it.
If the problem continues please contact Your local Distributor.		

MOA IR

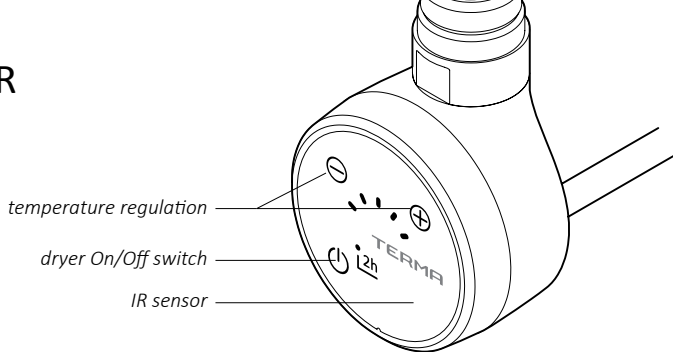

Turning the device on with the \ominus button will result in the radiator heating up to the set temperature. After reaching the set temperature the device will turn off and on regularly in order to maintain the set temperature.

The construction of the device as well as the physical characteristics of the heating agent inside the radiator, influence the way in which the heat is distributed — the temperature of the bottom pipes on the radiator (especially the two located at the very bottom of the radiator), may be lower than the temperature of the remaining parts of the radiator — this is a normal phenomenon.

Temperature increase

In order to increase the temperature of the radiator, press \oplus once or several times as required; the correct number of diodes will start blinking. The last blinking diode indicates the set temperature, whilst the last di-

ode which shines constantly, indicates the current temperature. The remaining diodes will start shining constantly on reaching subsequent temperature levels.

Temperature decrease

In order to decrease the temperature of the radiator, press \ominus once or several times as required; the correct number of diodes will start blinking. The last diode, which shines continuously, indicates the set temperature whilst the last blinking diode indicates the current temperature. The remaining diodes will start fading on reaching subsequent temperature levels.

Anti-freeze function

When the device is off and the temperature surrounding the temperature sensor drops to below 6°C, the device will switch on automatically. This is to prevent the heating agent inside the radiator from freezing. The activation of Anti-freeze mode is indicated by the blinking of the middle diode.

Dryer function

The Dryer turns the device on for 2 hours, e.g. in order to dry a towel. After this period of time the device automatically switches to the mode to which it was set before the dryer mode.

In order to activate the dryer mode, press and hold the **⊕** button (also when the heating element is off) – the device will start working and maintain the most recent temperature setting. You can now freely adjust desired temperature level (buttons **⊕** and **⊖**). After 2 hrs heater will revert to the previous setting (before dryer function activation).

To use 2 hrs timer heating element must be switched off. Switch it on by pressing and holding **⊕** button. After 2 hrs heater will switch off automatically.

Press **⊕** button at any time to interrupt the dryer mode.

Remote control mode (wireless communication)

If the device is located in a room with an external IR controller suitable for communication with the heating element, the first signal received by the heating element will automatically activate the reception mode. The device will maintain the temperature indicated by the external controller while continuing to limit the radiator temperature so that it does not exceed 60°C. The remote control mode is indicated by the middle diode. In case of communication loss longer than 25 minutes, the device will automatically switch back to the manual mode, and continue to operate according to the most recent setting. Any new signal received by the heating element, will switch it back to the remote control mode.

The dryer function can be activated in the remote control mode (when the dryer function is deactivated, the heating element will resume the reception of signals from the external controller).

Calibrating the temperature span

same as MOA

Problem solving

same as MOA

REG 2

Ring indicating that the device is operating

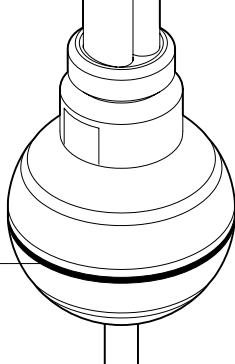

After the device is turned on, it heats the radiator up to 65° C. Having reached that temperature, the device will turn on and off regularly in order to maintain it.

The basic version of the device is not fitted with the on/off switch on the casing — it can be turned on/off by plugging it into a mains electricity socket (or connected permanently to the electricity circuit). A shining ring indicates that the device is connected to the electricity circuit.

Version +W of the device (not available in the UK) is additionally fitted with the on/off switch on the plug. The construction of the device as well as the physical characteristics of the heating agent inside the radiator influence the way in which the heat is distributed — the temperature of the bottom pipes on the radiator (especially the two located at the very bottom of the radiator) may be

lower than the temperature of the remaining parts of the radiator — this is a normal phenomenon.

Emergency situations

Should you discover any abnormalities in the way the device is operating, please check if:

- The device is correctly connected to the installation.
- The radiator is correctly filled with the appropriate heating agent.

If the heating element unit is still not working correctly, it should be uninstalled and returned to the Supplier/Seller.

REG 3

Temperature regulation ring with temperature setting indicators:

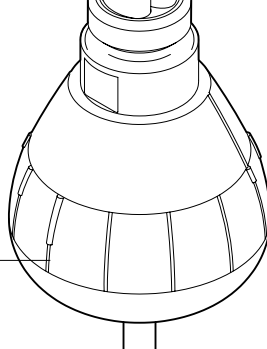

When the device is turned on, it heats the radiator up to the set temperature. Having reached that temperature, the device will turn on and off regularly in order to maintain it.

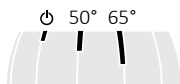

The construction of the device as well as the physical characteristics of the heating agent inside the radiator, influence the way in which the heat is distributed — the temperature of the bottom pipes on the radiator (especially the two located at the very bottom of the radiator) may be lower than the temperature of the remaining parts of the radiator — this is a normal phenomenon.

Emergency situations

Should you discover any abnormalities in the way the device is operating, please check if:

- The device is correctly connected to the installation.
- The radiator is correctly filled with the appropriate heating agent.

If the heating element unit is still not working correctly, it should be uninstalled and returned to the supplier.

Warranty terms & conditions

1. The subject of this warranty is a Terma electric heating element with control head. The product name and characteristics are specified on the packaging.
2. By accepting the device on purchase, the Client confirms that the product is of full value. The Client should immediately inform the Seller of any discovered faults — otherwise it will be understood that the Product was faultless at the time of purchase. This refers especially to any faults or damages of the control panel case.
3. The Warranty for period for the Product is 24 months from the date of purchase, but no longer than 36 months from the date of production.
4. The proof of purchase (receipt, invoice, etc.) constitutes the basis for warranty claims. Lack of the proof of purchase allows the manufacturer to reject a warranty claim.
5. This warranty does not cover any faults and/or damages caused by:
 - incorrect (not in accordance with the manual) installation, use or disassembly,
 - incorrect use of the heating element (i.e. for any purpose that is not specified by the Manufacturer as intended for this type of product),
 - unqualified persons tampering with the product,
 - customers after the purchase.
6. The Central Heating installation should be fitted with lock-shield valves, enabling disassembly of the radiator or the heating element and its control head without the necessity of emptying the whole system of the heating agent. Any problems or expenses arising from the absence of lock-shield valves in your installation cannot be used as grounds for any claims against Terma.
7. The attached Product Manual is an integral element of the Warranty. Please read it carefully prior to the installation and use of the Product.
8. The Manufacturer is obliged to remove any production fault within 14 working days of receipt of the faulty device at the Manufacturer's premises.
9. Should the repair be impossible, then the manufacturer is obliged to replace the faulty Product with a new, full-value unit of identical parameters.

EN Dual Fuel Radiator | **CZ** Ohříváč UT s elektrickým topným tělesem | **DE** Kombi-Heizkörper | **FR** Radiateur mixte | **IT** Radiatore misto | **PL** Grzejnik c.o. z grzałką elektryczną | **RU** Радиатор водно-электрический | **SK** Ohrievač ÚK s elektrickým vykurovacím telesom

EN NEVER OPERATE THE HEATING ELEMENT WITH BOTH VALVES CLOSED.

HINT: Do not turn on the heating element and your central heating at the same time.

CZ NIKDY NEZAPÍNEJTE OHŘÍVAČ, POKUD JSOU OBA VENTILY UZAVŘENY.

UPOZORNĚNÍ: Použijte ohříváč pouze tehdy, pokud je systém UT vypnutý.

DE SCHALTEN SIE DAS HEIZELEMENT NICHT EIN, WENN BEIDE VENTILE GESCHLOSSEN SIND.

HINWEIS: Verwenden Sie die Heizpatrone nur dann, wenn die Zentralheizung ausgeschaltet ist.

FR NE JAMAIS METTRE EN MARCHÉ LE KIT RÉSTANCES SI LES DEUX VANNES SONT FERMÉES.

NE PAS OUBLIER : utiliser le kit résistances uniquement quand le système du chauffage eau chaude est arrêté.

IT MAI USARE IL DISPOSITIVO CON ENTRAMBE LE VALVOLE CHIUSE.

Non accendere contemporaneamente il dispositivo e l'impianto di riscaldamento.

PL NIGDY NIE WŁĄCZAJ GRZAŁKI, JEŚLI OBA ZAWORY SĄ ZAMKNIĘTE.

WSKAZÓWKA: używaj grzałki tylko wtedy, kiedy system c.o. jest wyłączony.

RU ЗАПРЕЩАЕТСЯ ВКЛЮЧАТЬ ЭЛЕКТРОНАГРЕВАТЕЛЬ ЕСЛИ ВЕНТИЛИ ЗАКРЫТЫ.

ПОМНИТЕ: следует использовать электронагреватель только тогда, когда система Ц.О. отключена.

SK NIKDY NEZAPÍNAJTE OHRIEVAČ, AK SÚ OBA VENTILY UZATVORENÝ.

UPOZORNENIE: Používajte ohrievač iba vtedy, ak je systém ÚK vypnutý.

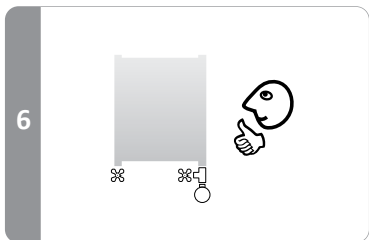
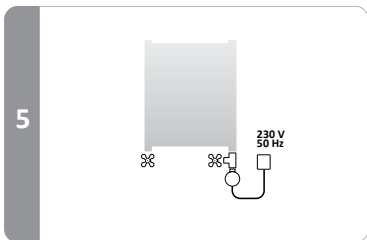
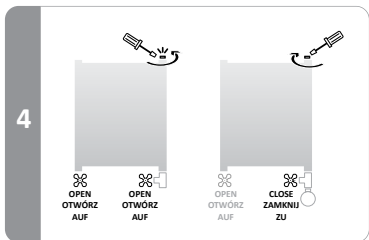
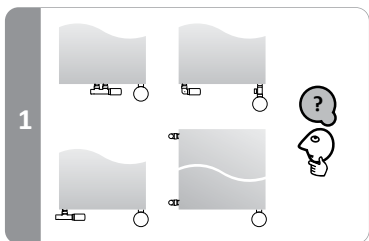

EN Electric only Radiator | **CZ** Elektrický ohřívač | **DE** Elektrischer Heizkörper | **FR** Radiateur électrique | **IT** Radiatore elettrico | **PL** Grzejnik elektryczny | **RU** Электрический радиатор | **SK** Elektrický ohrievač

1

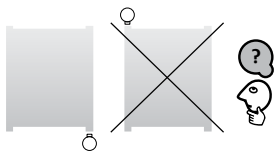

3

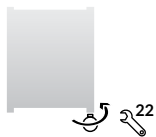

4

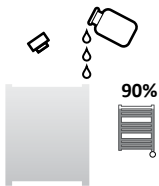

5

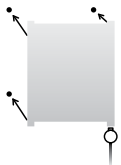

6

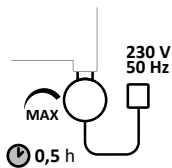

7

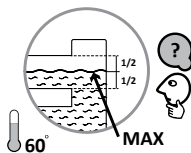

8

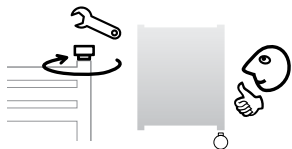

TERMA Sp z o.o.

Czaple 100, 80-298 Gdańsk, Poland

terma@termagroup.pl

www.termagroup.pl

20180423WOŁOSIUK KACPER MPGKE-269