

## **FOR MODELS:**

5060235344916 KUDOX ELECTRIC LADDER FLAT D DRY TOWEL RAIL 400mmx700mm 210 Watts CHROME

5060235344923 KUDOX ELECTRIC LADDER FLAT D DRY TOWEL RAIL 500mmx1000mm 350Watts CHROME

## **WARNINGS**

**Keep this instruction sheet with care and read it carefully before using this device. You will so obtain the best performance with the highest safety.**

- This appliance is intended only for drying textiles washed in water.
- This towel rail must be earthed.
- Before use, please check that the voltage of the network and that of the appliance are the same (pls. see the technical label).
- Always switch off the electricity supply at the mains during cleaning and maintenance.
- Electrical safety is guaranteed only if the element is connected to a suitably earthed electricity supply, according to the regulations in force.
- If the supply cord is damaged, it must be replaced by the manufacturer or similar qualified persons in order to avoid hazard.  
Failure to comply with the above may endanger the safety of the whole system.
- The rail will get very HOT so is NOT suitable for use in locations where this could cause a hazard (e.g. where infirmed persons or young children will be present unsupervised).
- The element must be permanently connected to a suitable electricity supply by way of the cable provided. This should be via a fused spur in accordance with the IEE Wiring Regulations.

## **IMPORTANT INFORMATION**

This product must be installed by a competent person and in accordance with the current IEE Wiring Regulations. It may be necessary to notify your local authority building control department or to have the work carried out by a suitably qualified electrician.

The surface of the towel warmer may get very hot so it is not suitable for use in locations where this could be a hazard. In order to avoid a hazard for very young children this appliance should be installed so that the lowest heated rail is at least 600mm above floor level.

This appliance can be used by children aged from 8 years and above and persons with reduced physical, sensory or mental capabilities or lack of experience and knowledge if they have been given supervision or instruction concerning use of the appliance in a safe way and understand the hazards involved. Children shall not play with the appliance. Cleaning and user maintenance shall not be made by children without supervision.

The element contains a non-adjustable thermostat that will switch off and on as the towel warmer reaches temperature. The element also contains a non-replaceable thermal fuse safety device that will blow at 119 degrees centigrade if the thermostat were ever to fail.



PLEASE ENSURE THAT YOU WEAR ALL NECESSARY PERSONAL PROTECTIVE EQUIPMENT FOR YOUR SAFETY. Please check that all components are present and that you are ENTIRELY happy with the size, design and finish BEFORE starting installation.

## **Pack Contents**

1 x Electric Towel Rail	4 x Bracket Front	4 x Wall Screw
4 x Bracket Base	4 x Bracket Cover	4 x Washer
4 x Bracket Stem	4 x Wall Plug	4 x Bracket Screw
		4 x Mini Screws

## MOUNTING THE TOWEL RAIL ON THE WALL

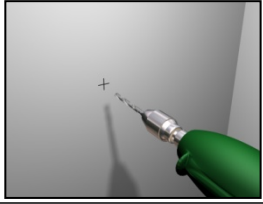
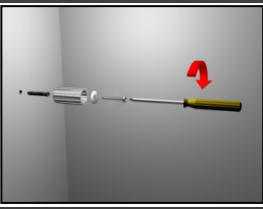
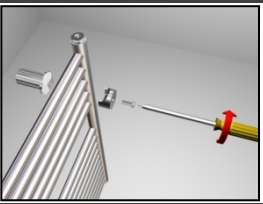
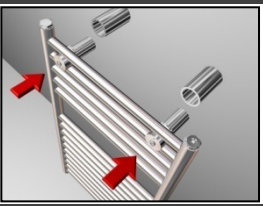
This appliance should be fixed on the wall as described below. Only the fixing kit provided with the appliance should be used. No adhesive shall be used since they are not considered to be a reliable fixing means.

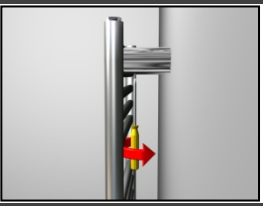
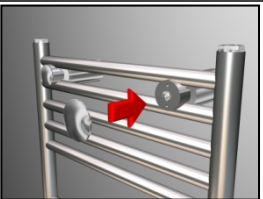
<p><b>STEP 1.</b> Select your desired mounting position and check that the wall is sufficiently strong enough to hold the weight of the towel rail. Mark your preferred bracket positions on the wall and drill holes as necessary for the fixings that you are using. The Wall Plugs supplied are only suitable for solid walls. Please note: If the wall is other than a solid construction other means of fixings will be required.</p>	
<p><b>STEP 2.</b> Screw the Bracket Base to the wall using the Wall Screws and Washers provided.</p>	
<p><b>STEP 3.</b> Loosely fit the Bracket Stems to the towel rail with the Bracket Fronts and Bracket Screws.</p>	
<p><b>STEP 4.</b> Align the Bracket Stems with the Bracket Bases and push the towel warmer back into position.</p>	
<p><b>STEP 5.</b> Tighten the Bracket Screws with a screwdriver.</p>	
<p><b>STEP 6.</b> Insert the Mini Screws into the Bracket Bases and tighten with a screwdriver to lock bracket into position.</p>	
<p><b>STEP 7.</b> Push the Cover Caps into position on the Bracket Fronts.</p>	

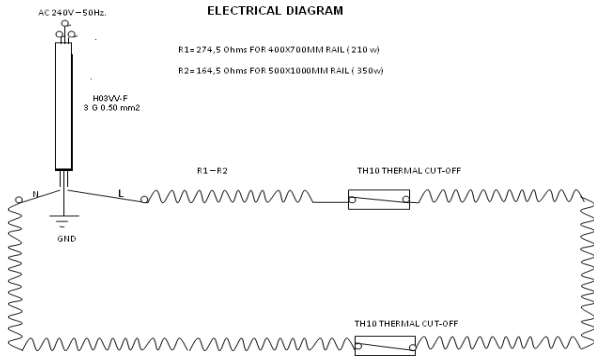

## ELECTRICAL SPECIFICATIONS:

MODEL: 5060235344916 KUDOX ELECTRIC LADDER FLAT D DRY

TOWEL RAIL 400mmx700mm :

V= AC 240V – 50Hz. P= 210W I= 0,875A

MODEL: 5060235344923 KUDOX ELECTRIC LADDER FLAT D

DRY TOWEL RAIL 500mmx1000mm:

V= AC 240V – 50Hz. P= 350W I= 1,46A

## ELECTRICAL CONNECTION

Always switch off the electricity supply at the mains during installation. The electrical connection must be carried out by a competent person and in accordance with the current IEE Wiring Regulations. It may be necessary to notify your local authority building control department or to have the work carried out by a suitably qualified electrician.

Single-pole switches and single-pole protective devices that disconnect the towel rail from the supply mains, shall be connected to the phase conductor.

### Connecting the power supply cable to the mains (AC240V – 50Hz.)

**GREEN & YELLOW = EARTH**

**BLUE = NEUTRAL**

**BROWN = LIVE**

## CARE AND MAINTENANCE

- Regular cleaning with a soft cloth will keep the surfaces of your towel warmer looking new.
- Soapy water can be used to remove stubborn stains and then buff dry with a soft cloth.
- Do not use abrasive or chemical cleaners to clean your towel warmer as these will damage the surface finish over time.

## DISPOSAL



This appliance is NOT an ordinary domestic refuse. It must be disposed of through the appropriate recollection centres to be recycled. In case of replacement it can be sent back to your distributor.

This handling of the product's end of life will allow us to preserve our environment and curb the consumption of natural resources. This symbol applied on the product, indicates the obligation to consign it to a special recollection centre to be disposed of in accordance with European Directive WEEE 2002/96/EC guideline. The manufacturer reserves the right to modify the product without previous notice for technical or construction improvements.

This towel rail is warranted for a period of 1 year against manufacturing defects only. Kudox warranty covers replacement of product or refund only. The Kudox warranty does not cover, offer or imply cover for any consequential losses whatsoever. Claims for consequential losses will not be entertained.

### UK TECHNICAL SUPPORT LINE 020 75899617

Kudox Limited  
1 Bray Place  
London  
SW3 3LL

www.kudox.com

e-mail: support@kudox.com

Made in Turkey