

# SALUS<sup>®</sup> C O N T R O L S

Model: RT510RF



Installation Manual

Product compliance .....	3
Safety Information .....	3
Box content .....	3
Introduction .....	3
Features .....	4
Installation .....	5
1. RXRT510 Receiver .....	5
Button Description for RXRT510 Receiver .....	6
2. RT510RF Thermostat .....	6
Power up .....	6
DIP Switch Settings .....	7
Button Functions .....	7
LCD Functions .....	8
Pairing procedure .....	8
Pair the RT510RF and RXRT510 .....	8
Testing procedure .....	9
Installer Mode .....	10
Operations .....	11
Setting the time .....	11
Programming the RT510RF .....	12
Functions .....	14
Review the Setpoint temperature .....	14
Temporary Override .....	14
Permanent Override .....	15
Boost Function .....	15
a. Boost Function in Normal Mode .....	16
b. Boost Function in Permanent Override Mode .....	16
c. Boost Function in Temporary Override Mode .....	17
d. Boost Function in Frost/Holiday Mode .....	18
Frost Function .....	18
Holiday Function .....	19
Other Functions .....	20
Backlight .....	20
Battery Status .....	20
Sleep Mode .....	20
Reset Function .....	21
Technical Information .....	21
Warranty .....	22

## Product compliance

This product complies with the essential requirements and other relevant provisions of the following EU Directives: 2014/30/EU, 2014/35/EU, 2014/53/EU and 2011/65/EU. The full text of the EU Declaration of Conformity is available at the following internet address: [www.saluslegal.com](http://www.saluslegal.com).

## Safety Information

Use in accordance with the EU and national regulations. For indoor use only. Keep your device completely dry. This product must be installed by a competent person and in accordance with all the EU and national regulations.



**Always isolate the AC Mains supply before installing or working on any components that require 230 VAC 50Hz supply.**

## Box content



1x RT510TX



2x screws and plugs

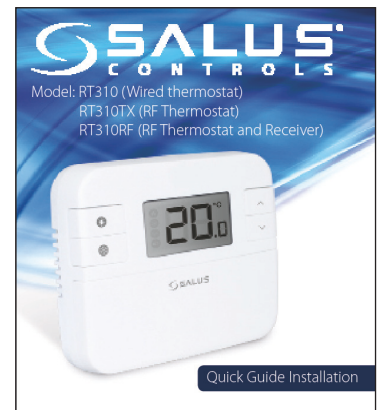

Quick Guide Installation



1x RXRT510

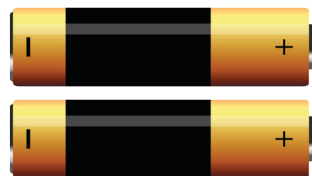

2x AA batteries



1x Thermostat Stand

The programmable room thermostat RT510RF is both a programmer and a room thermostat. A programmer allows you to set 'On' and 'Off' time periods to suit your own lifestyle. A room thermostat works by sensing the air temperature, switching on the heating when the air temperature falls below the thermostat setting and switching it off once this set temperature has been reached.

So, a programmable room thermostat lets you choose what times you want the heating to be on, and what temperature it should reach while it is on.

It will allow you to select different temperatures in your home at different times of the day (and days of the week) to meet your particular needs.

Turning a programmable room thermostat to a higher setting will not make the room heat up any faster. How quickly the room heats up depends on the design of the heating system, for example, the size of boiler and radiators. Neither does the setting affect how quickly the room cools down. Turning a programmable room thermostat to a lower setting will result in the room being controlled at a lower temperature, and saves energy.

The way to set and use your programmable room thermostat is to find the lowest temperature settings that you are comfortable with at the different times you have chosen, and then leave it alone to do its job. The best way to do this is to set low temperatures first, say 18°C, and then turn them up by one degree each day until you are comfortable with the temperatures. You won't have to adjust the thermostat further. Any adjustments above these settings will waste energy and cost you more money.

If your heating system is a boiler with radiators, there will usually be only one programmable room thermostat to control the whole house. But you can have different temperatures in individual rooms by installing thermostatic radiator valves (TRVs) on individual radiators.

If you don't have TRVs, you should choose a temperature that is reasonable for the whole house. If you do have TRVs, you can choose a slightly higher setting to make sure that even the coldest room is comfortable, then prevent any overheating in other rooms by adjusting the TRVs.

The time on the programmer must be correct. Some types have to be adjusted in spring and autumn at the changes between Greenwich Mean Time and British Summer Time. You may be able to temporarily adjust the heating programme, for example, 'Temporary / Permanent Override' or 'Boost'. All these functions are explained in the following pages of the Instructions Manual.

Programmable room thermostats need a free flow of air to sense the temperature, so they must not be covered by curtains or blocked by furniture. Nearby electric fires, televisions, wall or table lamps may prevent the thermostat from working properly.

The RT510RF from SALUS Controls is a stylish and accurate 5/2 or 24h programmable electronic thermostat with a large, easy to read Liquid Crystal Display (LCD). This programmable thermostat has been specifically designed to be used for both Volt Free and AC heating applications. This programmable thermostat can replace most common residential thermostats and is designed to be used with electric, gas or oil heating control systems.



## Features

- 5/2 days or 24h programming flexibility
- Built-in start up programming for quick installation
- Volt free contacts
- Frost protection
- Large, easy to read LCD with blue backlight
- Burner on symbol
- User friendly
- Stylish casing
- Holiday Mode
- Boost Function

## Installation

### 1. RXRT510 Receiver

Unscrew the backplate of the RXRT510 receiver in order to do the wiring connections. After that please switch the receiver ON.

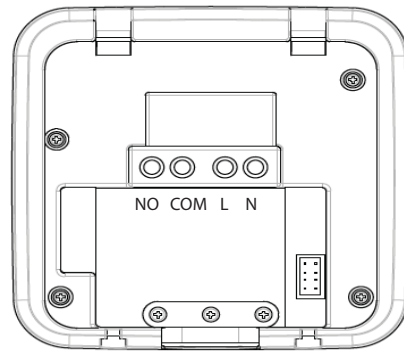
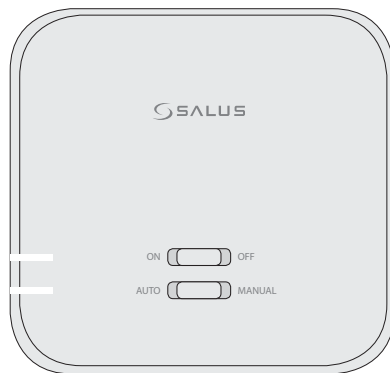

Terminal	Description	Receiver Terminals
NO	Switch Terminal	
COM	Common Switch Terminal	
L	Mains Live (230VAC)	
N	Mains Neutral	

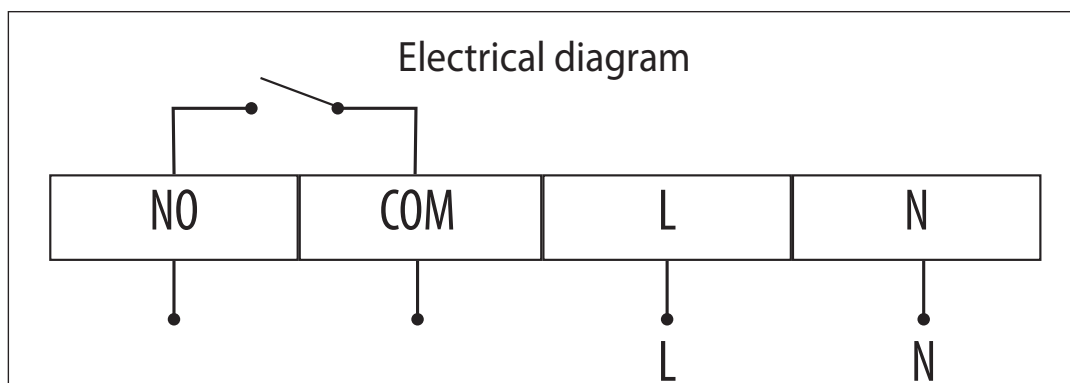

## Button Description for RXRT510 Receiver

Button	Function
ON	The receiver is enabled, ready for use.
OFF	The receiver is disabled, will not function.
AUTO	The receiver will switch on and off automatically, as operated by the thermostat.
MANUAL	Providing ON is selected, the receiver will switch on continuously, overriding the thermostat.

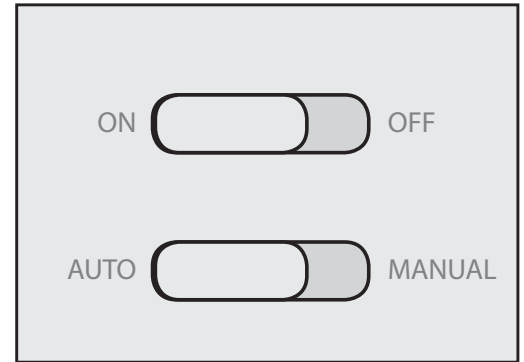

**Note:** Please make sure to first wire up and turn on the receiver. After that insert the batteries into the thermostat and follow the installation steps.

## 2. RT510RF Thermostat

Insert the batteries into the thermostat. Please use 2 AA batteries.

### Power up

After power up, the thermostat is reset. During system reset, all LCD icons are displayed for 2 seconds and the keys are locked. After that, all keys are unlocked and the thermostat is initialized. Then software version is shown. The typical reset display is shown below.

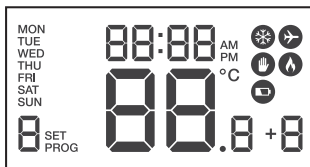

The following tables show the default settings of the RT510 thermostat after Power on, or after Reset button is pressed:

Function	Status after Reset
Operation Mode	Normal mode
Room Temperature	22.0°C, to be renewed within 5 seconds
°C indicator	On
Clock	12:00
AM/PM indicator	AM
Program	Default factory setting
Setpoint Temperature	Default factory setting
Program Number indicator	1
SET indicator	Off
PROG indicator	Off
Frost Protection indicator	Off
Heat indicator	Off
Low-Battery Warning indicator	Off, to be renewed within 5 seconds
Output Relay	Off

Program	Weekday (M to F)	Weekend (SA to SU)
1	Time: 6:00am Setpoint Temp: 21.0°C	Time: 8:00am Setpoint Temp: 21.0°C
2	Time: 8:00am Setpoint Temp: 14.0°C	Time: 10:00am Setpoint Temp: 19.0°C
3	Time: 12:00pm Setpoint Temp: 14.0°C	Time: 12:00pm Setpoint Temp: 19.0°C
4	Time: 2:00pm Setpoint Temp: 14.0°C	Time: 2:00pm Setpoint Temp: 19.0°C
5	Time: 6:00pm Setpoint Temp: 21.0°C	Time: 6:00pm Setpoint Temp: 21.0°C
6	Time: 10:00pm Setpoint Temp: 14.0°C	Time: 10:00pm Setpoint Temp: 14.0°C

## DIP Switch Settings

The DIP switches are found on the rear of your thermostat and can be used to change the span (temperature accuracy) of your thermostat from the default  $\pm 0.5^{\circ}\text{C}$  to  $\pm 0.25^{\circ}\text{C}$  and the programmes 5-2 or 24h. Changing the Span DIP Switch (2) may cause your boiler to operate more frequently. The DIP switches are located on the back of the thermostat.

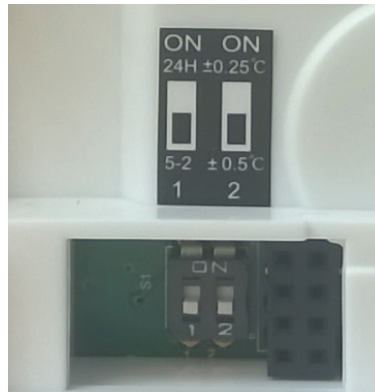
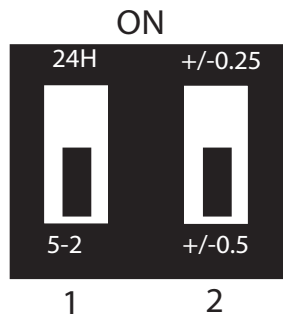

## Button Functions

Key	Function
	Press once to activate Frost Mode
	Press for 3 seconds in order to activate Holiday Mode.
+Hr	Press once to activate/deactivate Boost function
	Press once to enter/exit Permanent Override function.
^	Increase button
v	Decrease button
	Select the clock or programme settings
	Press to confirm your settings
	1. Press once to enter in Test Mode for RT510RF 2. Press for 3 seconds to enter/exit Pairing Mode for RT510RF
+ ^ + v	Press the buttons for 3 seconds to enter Installer Mode
 + 	Press the buttons for 3 seconds to enter Clock Settings

## LCD Functions

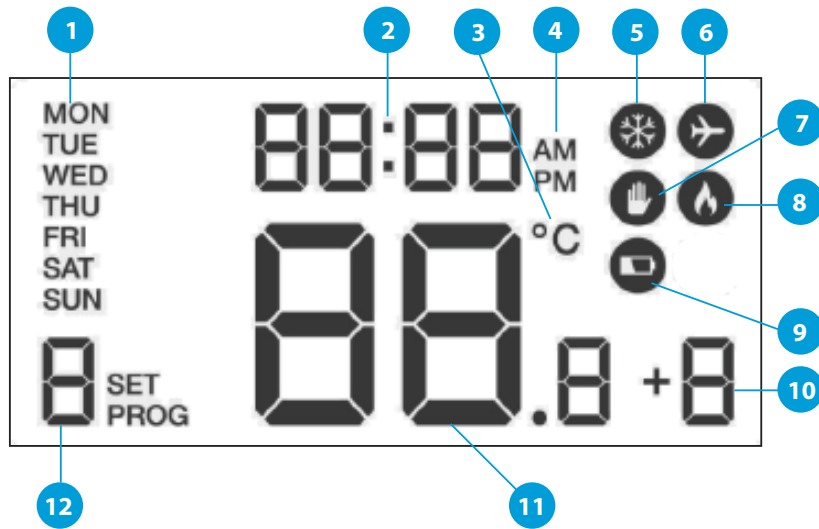

- |                                     |                                       |
|-------------------------------------|---------------------------------------|
| <b>1</b> Current day of the program | <b>7</b> Temporary/Permanent Override |
| <b>2</b> Current time               | <b>8</b> Heating Mode ON              |
| <b>3</b> Temperature unit           | <b>9</b> Low battery                  |
| <b>4</b> AM/PM                      | <b>10</b> Boost Mode ON               |
| <b>5</b> Frost Mode ON              | <b>11</b> Current temperature         |
| <b>6</b> Holiday Mode ON            | <b>12</b> Current program             |

## Pair the RT510RF and RXRT510

Please make sure that the thermostat and the receiver are paired. In order to do this you can use the Pairing or the testing procedure. The Testing procedure will allow you to check if the devices are communicating between them. The Pairing procedure will allow you to set up a communication between them.

### Pairing procedure

**Note:** Turn the receiver off and on again (ON-OFF-ON). The red LED will start flashing.

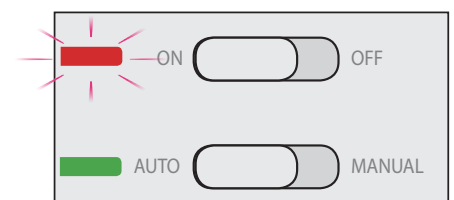
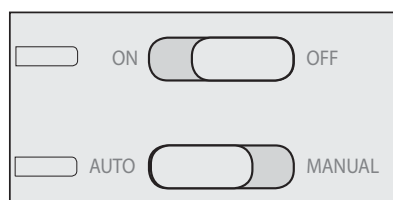
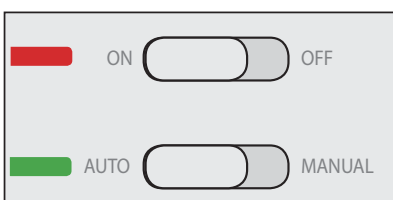

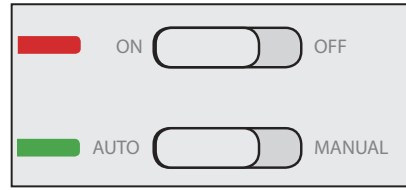
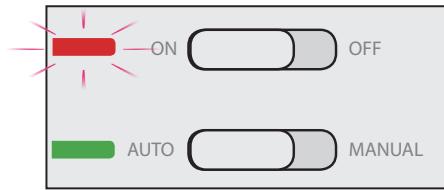
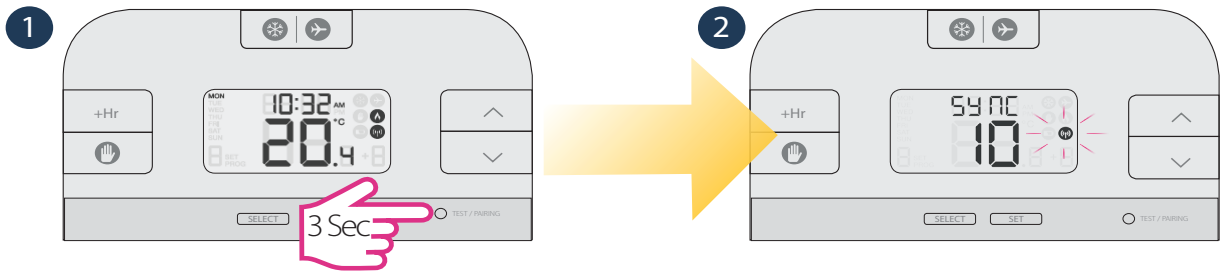

**Note:** For ending the pairing process you have two options. You can either wait for 10 min until the pairing process will automatically end or you can follow the steps below.

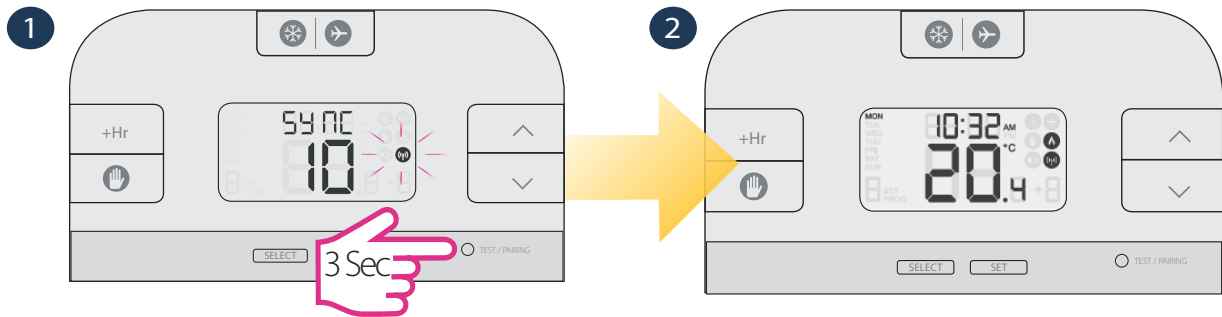

### Testing procedure

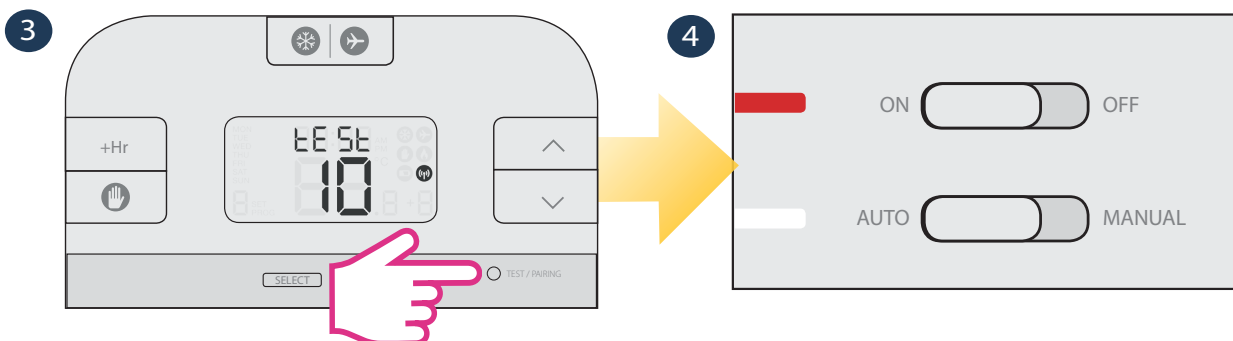
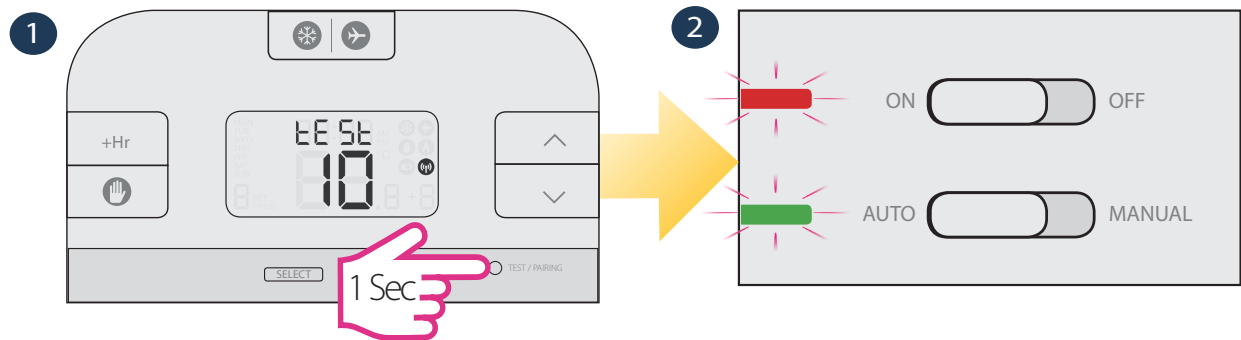



## Installer Mode

For any advanced settings please access the Installer Mode. Here you will have the possibility to adjust your frost setpoint, to set the temperature offset and also to choose from two temperature increments. Please follow the steps below in order to modify the installer parameters.

dxx	Function	Parameter	Description	Default value
d01	Temperature display increments	0.1 or 0.5°C	Select temperature display increments	0.5°C
d02	Temperature offset	+/-3.0°C	Calibrate your thermostat temperature	0.0°C
d03	Frost setpoint	5.0-17.0°C	Set the Frost Point temperature	5.0°C

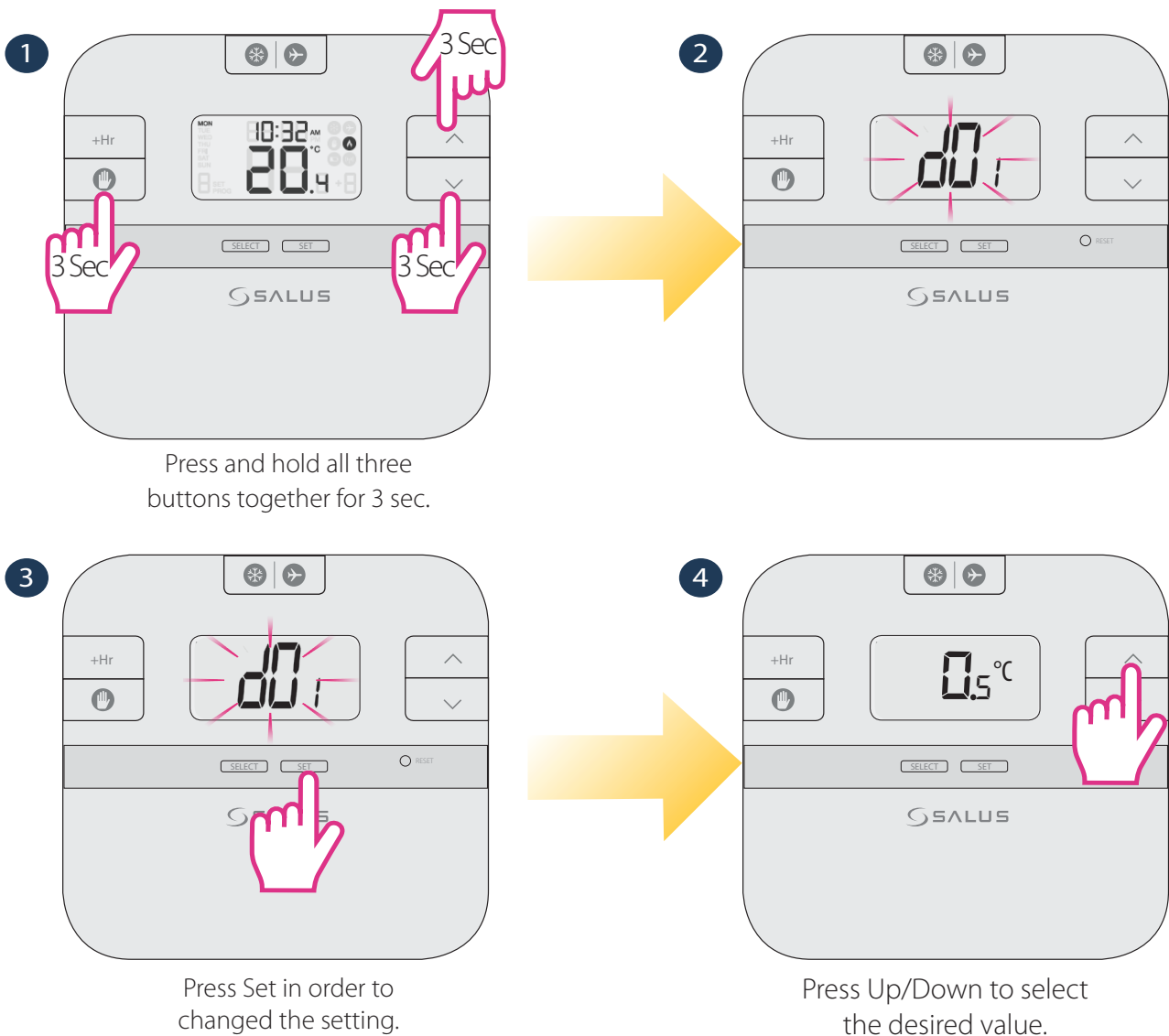

The RT510RF is configured and adjusted by the use of a minimal number of user controls, and an intuitive user interface. The Backlight Liquid Crystal Display (LCD) gives a highly visible, easily readable indication of the programmable thermostat status.

## Setting the time

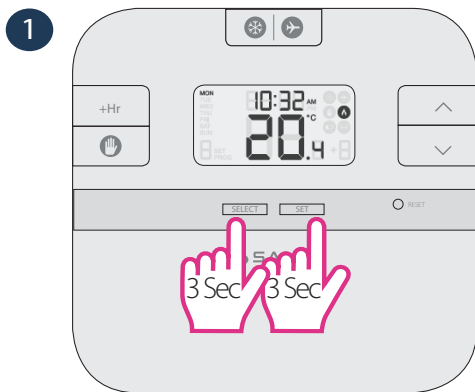

Press the buttons together for 3 sec.

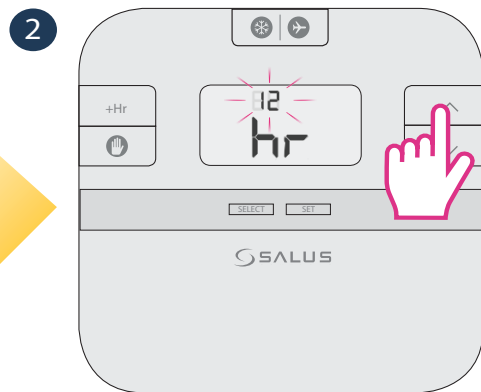

Press Up or Down to select the hour format.

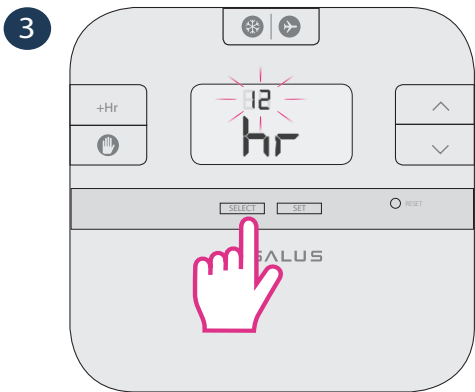

Press Select to confirm.

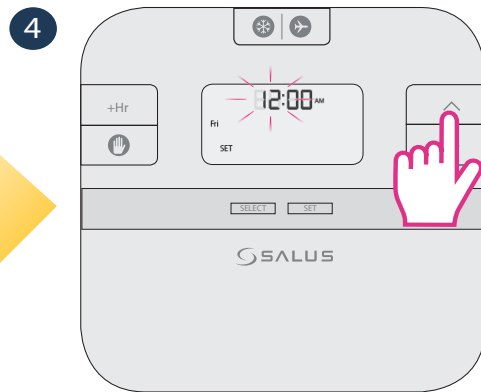

Press Up or Down to set the hour.

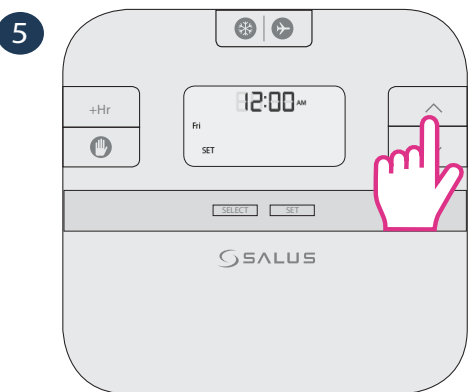

Press Select and after that Up or Down to set the minutes.

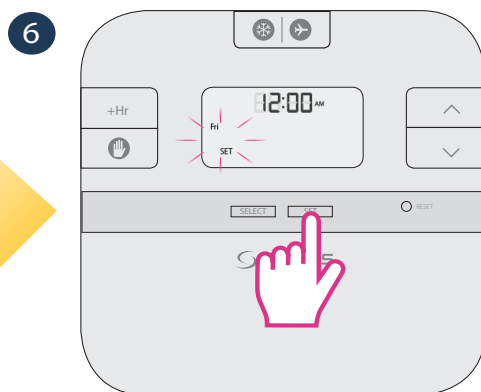

Continue with the same steps for setting the Day. Press Set to save your options and return to the main Screen.

## Programming the RT510RF

You can create personalized programmes for your thermostat. You have the option to choose between a 5-2 days programme or a daily one by using the DIP Switches.

RT510RF	
5-2 Days Programme	24h Programme
Weekdays 6 sets of time/channel	24h 6 sets of time/channel
Weekends 6 sets of time/channel	
<b>Total: 12 settings/week</b>	<b>Total: 42 settings/week</b>

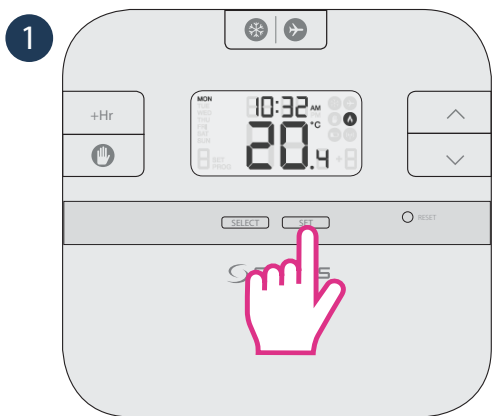

Press Set to change your programmes.

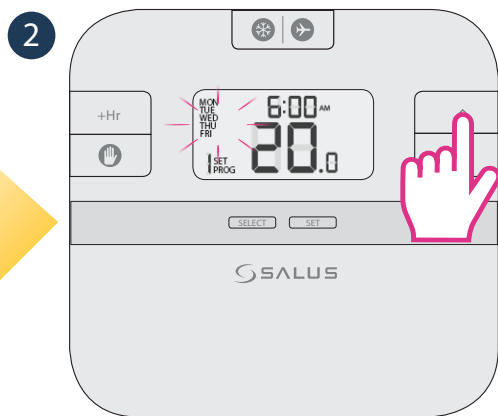

Press Up or Down to select Weekday, Weekend or the Day for which you want to create the program

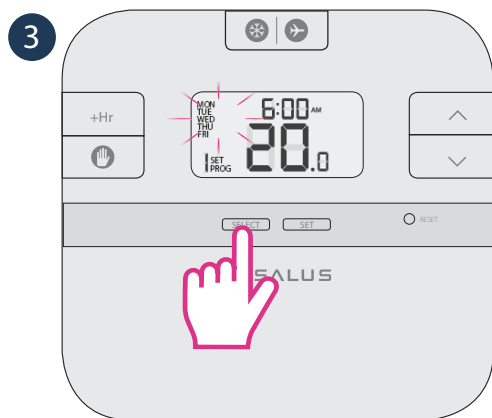

Press Select to confirm your option.

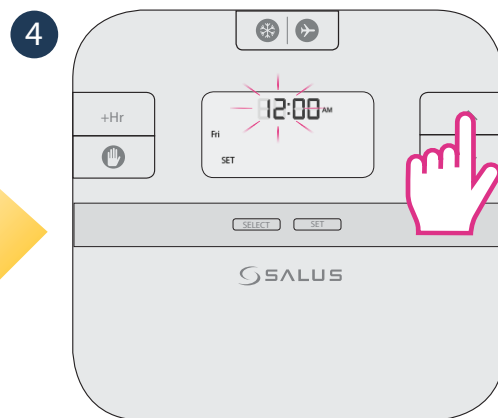

Press Up/Down to set the hour.

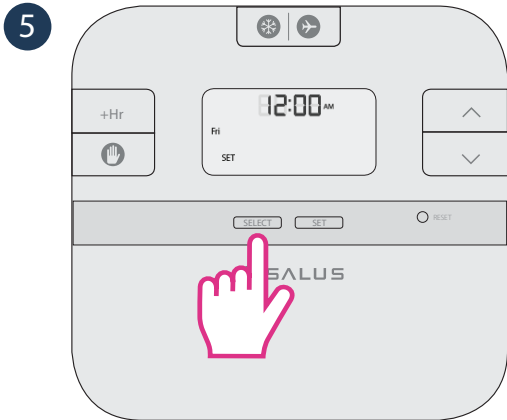

Press Select to confirm your option.

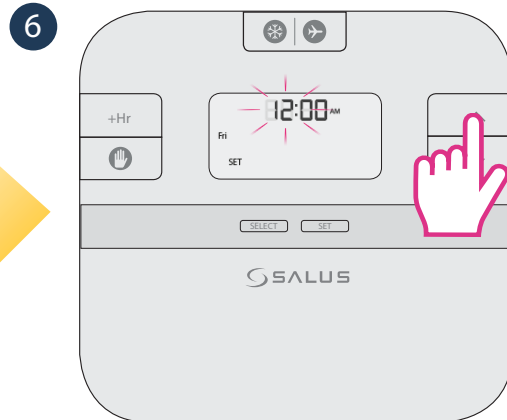

Press Up/Down to set the minutes.

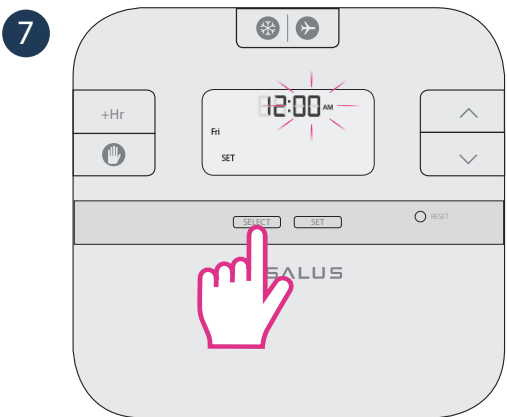

Press Select to confirm your option.

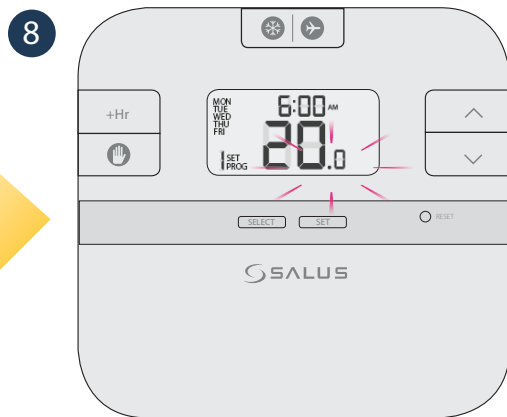

Press Up/Down to set the temperature.

Repeat the steps above for programs 2-6. After you have done all the changes, please press SET to confirm all your choices and to return to the Main Screen.

**Note:** Don't forget to move the DIP Switch to 24h in order to have the individual programme active. After that please follow the same instructions as for the 5-2 days programme.

## Review the Setpoint temperature

When no button is pressed, your thermostat is showing the actual temperature of the room. To review the setpoint (desired) temperature follow the steps below:

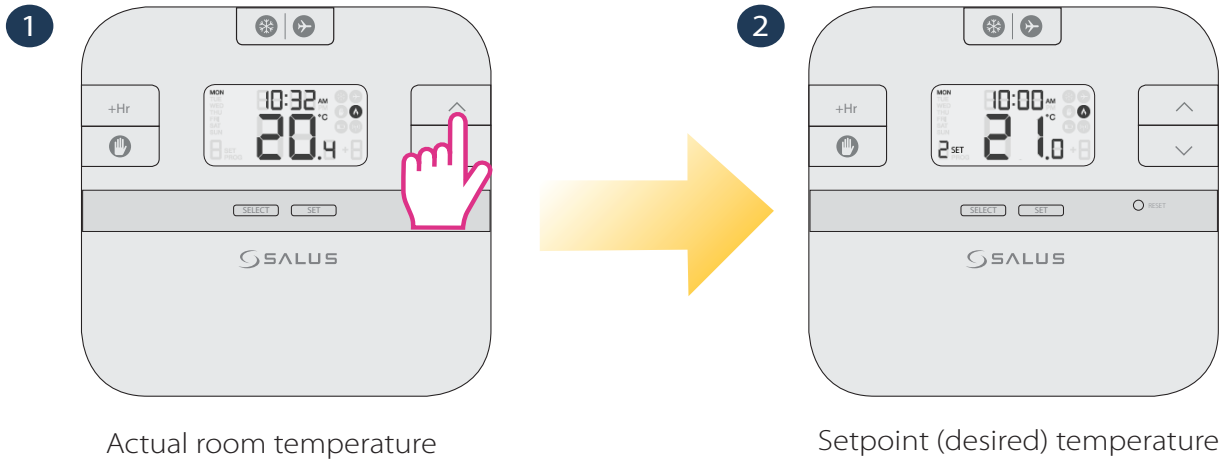

## Temporary Override

When the temporary override is active, the setpoint temperature will be changed until the next program starts.

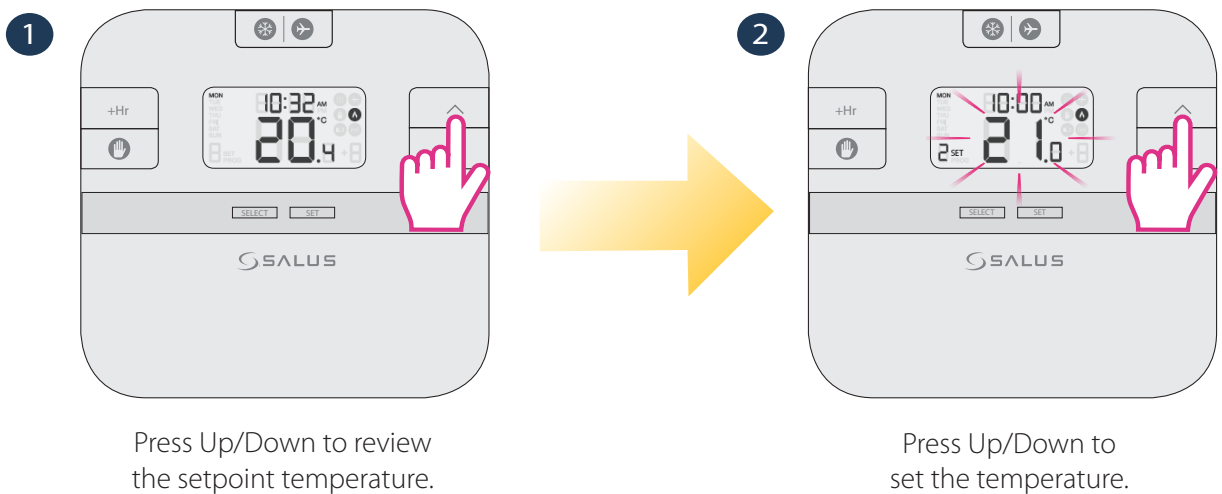

**Note:** To exit the temporary override procedure, you can wait for 3 seconds until the set temperature stops flashing or you can press on the SET button once.



## Permanent Override

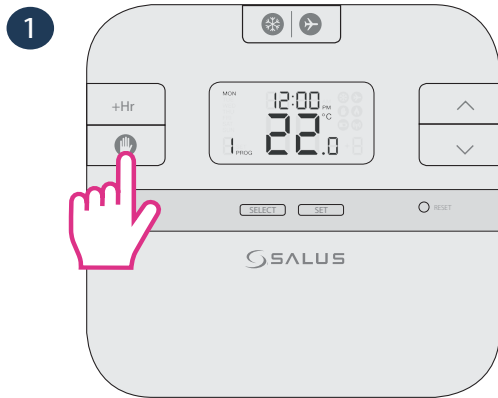

Press Override in order to activate the mode.

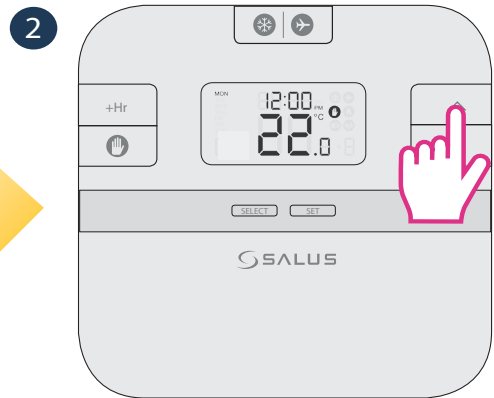
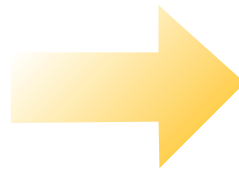

Press Up or Down to set the temperature.

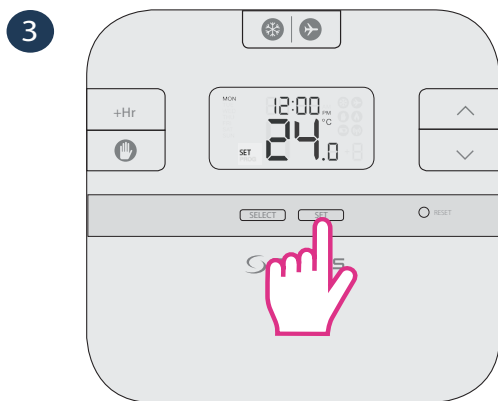

Press Set to save the changes.

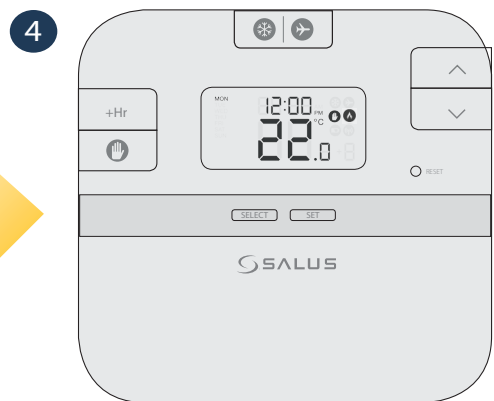
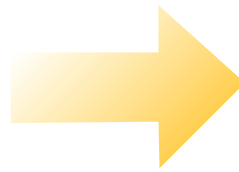

The Override sign will appear on the main screen.

**Note:** To exit the temporary override procedure, you can wait for 3 seconds until the set temperature stops flashing or you can press on the SET button once.

## Boost Function

Boost function can be activated when your thermostat is in Normal Mode, in Temporary or Permanent Override. You cannot set the Boost when in Frost or Holiday Mode. With Boost mode activated you can override, temporary override or permanently override the thermostat by setting the period of time and also by changing the Setpoint temperature.

See below the explanations for the Boost Mode settings that are available for each of the modes set on the thermostat. Please follow the one that suits you needs:

## a. Boost Function in Normal Mode

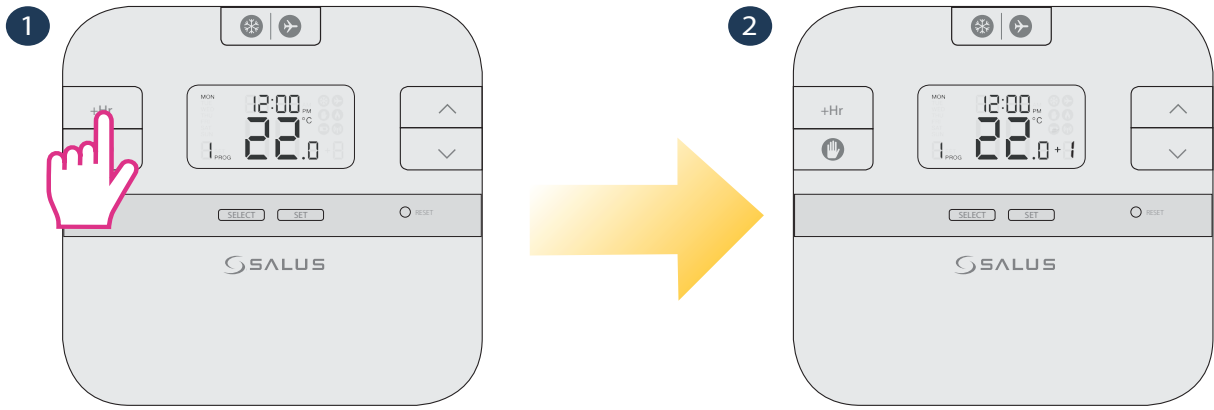

Each press on +Hr means an extra hour added on the Boost function. The maximum is +9 hours.

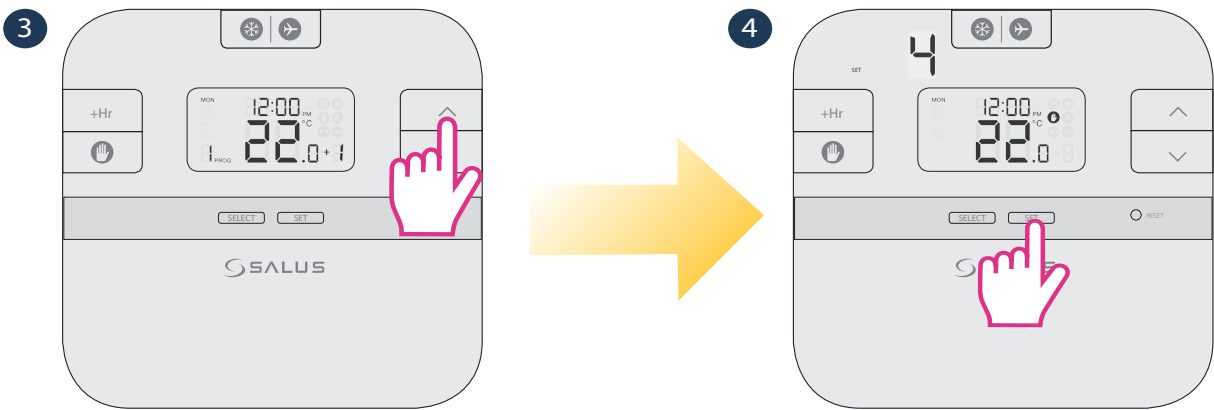

Press Up or Down to set the temperature.

After the temperature is set press Set to save your options and to return to Main screen.

**Note:** RT510RF will work in Boost Mode for up to 9 hours, set on the desired temperature. After the Boost time is over, the thermostat will return to Normal Mode and will follow the schedule created by you.

## b. Boost Function in Permanent Override Mode

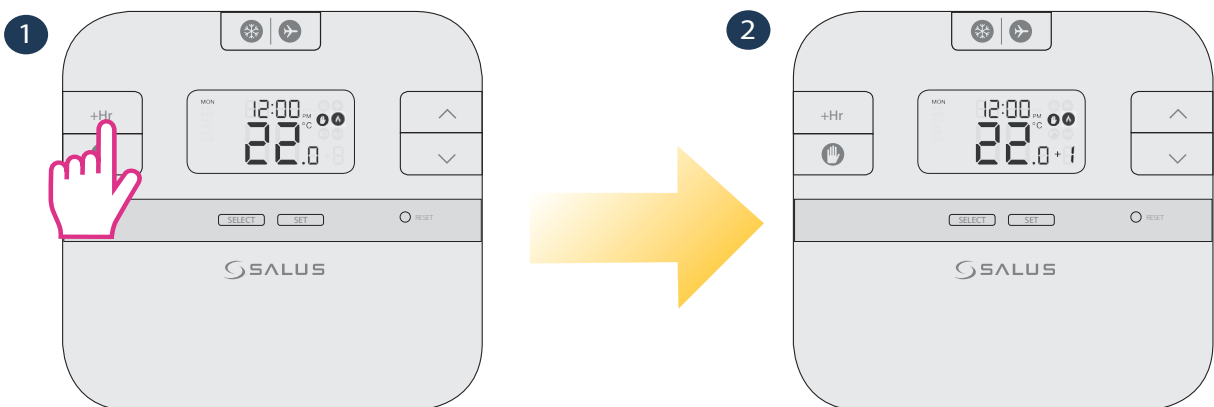

Each press on +Hr means an extra hour added on the Boost function. The maximum is +9 hours.

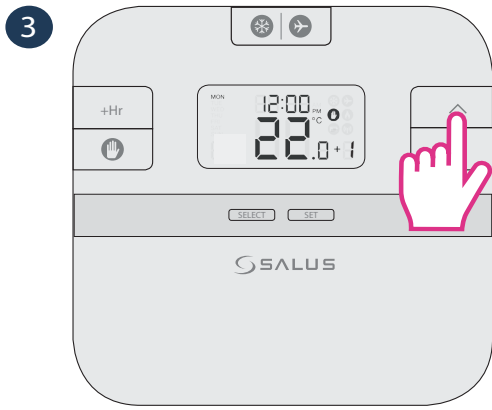

Press Up or Down to set the temperature.

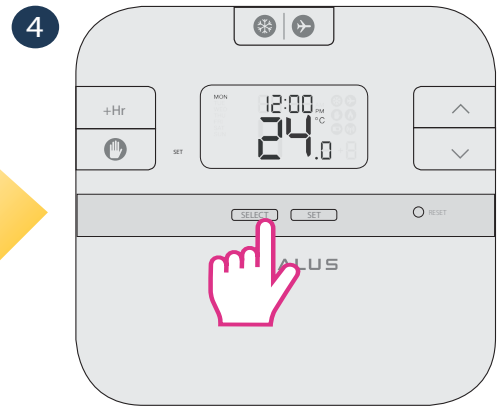
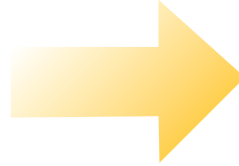

After the temperature is set press Set to save your options and to return to main screen.

**Note:** RT510RF will work in Boost Mode for up to 9 hours, set on the desired temperature. After the Boost time is over, the thermostat will return to the Permanent Override Mode.

### c. Boost Function in Temporary Override Mode

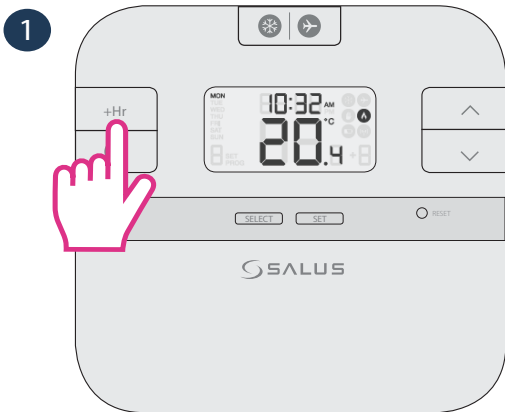

Each press on **+Hr** means an extra hour added on the Boost function. The maximum is +9 hours.

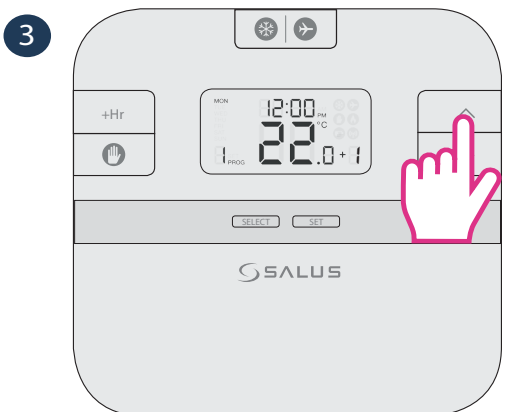
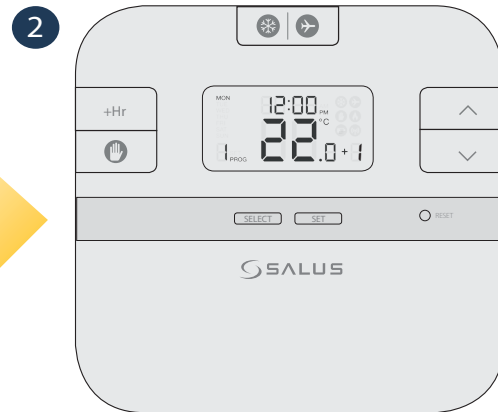
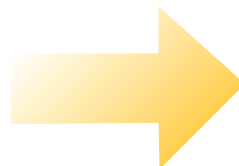

Press Up or Down to set the temperature.

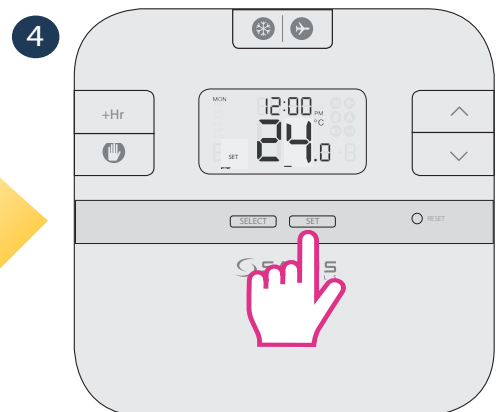
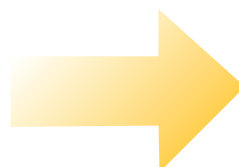

After the temperature is set press Set to save your options and to return to main screen.

**Note:** RT510RF will work in Boost Mode for up to 9 hours, set on the desired temperature. After the Boost time is over, the thermostat will return to Normal Mode, following the schedule set by you.

## d. Boost Function in Frost/Holiday Mode

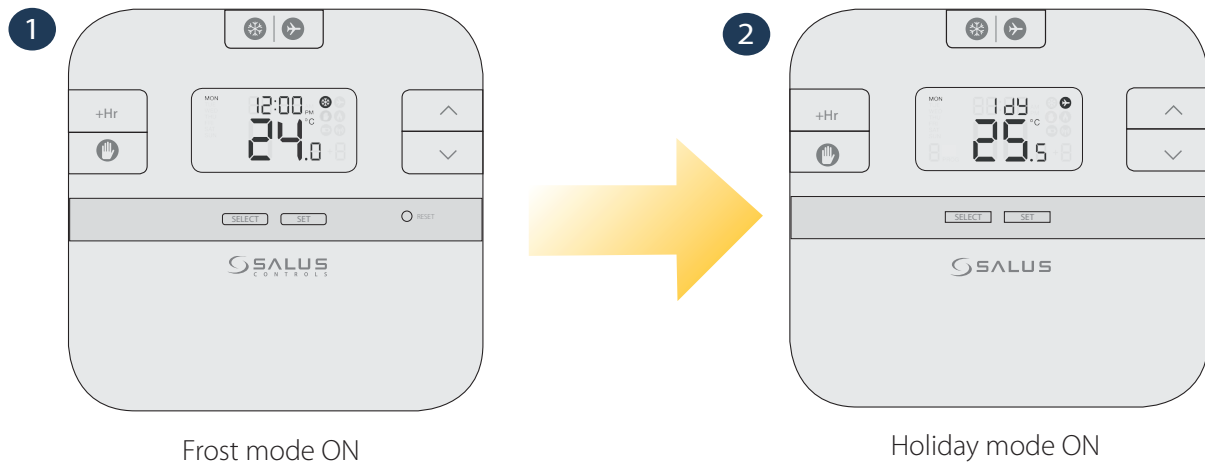



**Note:** When Frost/Holiday Mode are activated, the Boost function will be canceled. Also, you cannot activate the Boost function when the thermostat is set in Frost or Holiday Mode.

## Frost Function

Frost function allows you to turn the Frost protection ON or OFF. The frost setpoint temperature is preset at 5°C. You can change the frost setpoint temperature by modifying the Installer Mode parameters, d03. If the room temperature is lower than the Frost setpoint then the thermostat will automatically change to Frost mode ON.

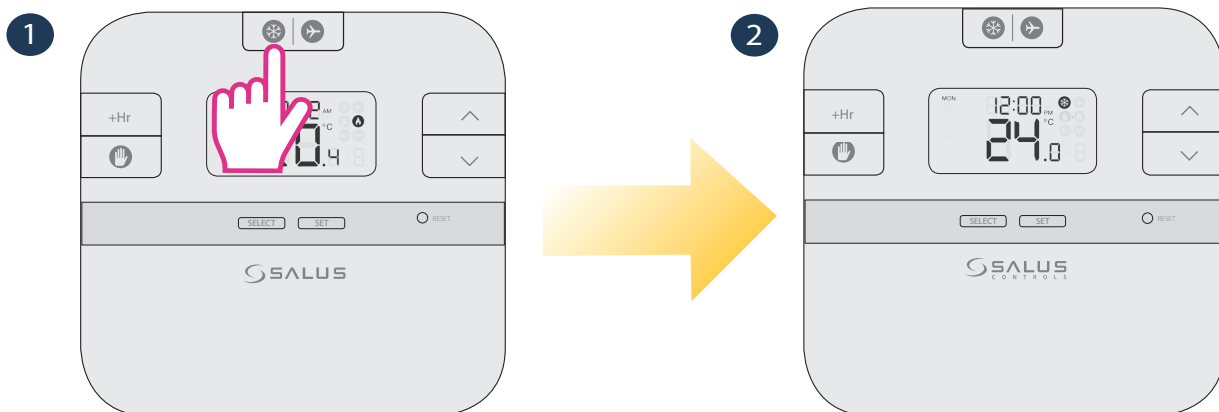
Follow the steps below for setting up the Frost Mode.



Press the  once for turning the Frost protection ON.

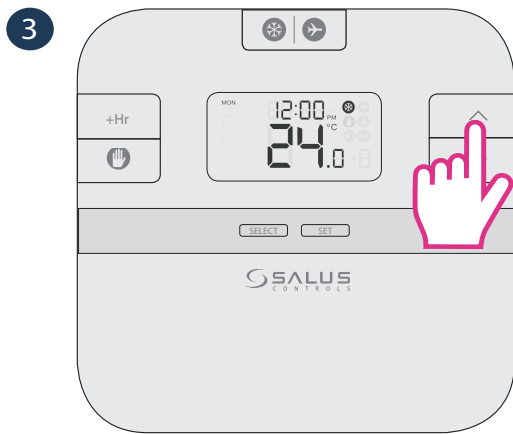

Press Up/Down to review the frost setpoint temperature.

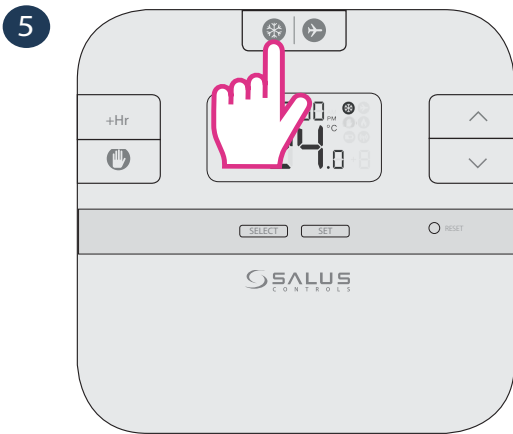
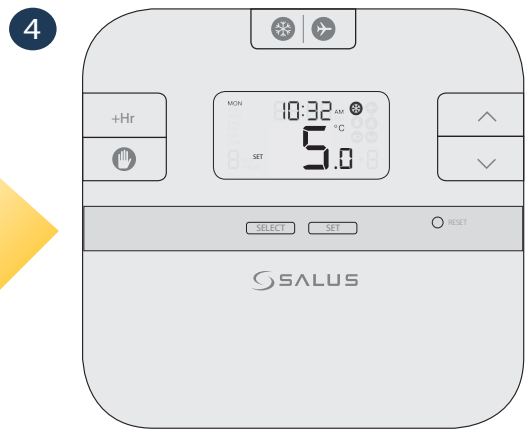

Press the  once for turning the Frost protection OFF.

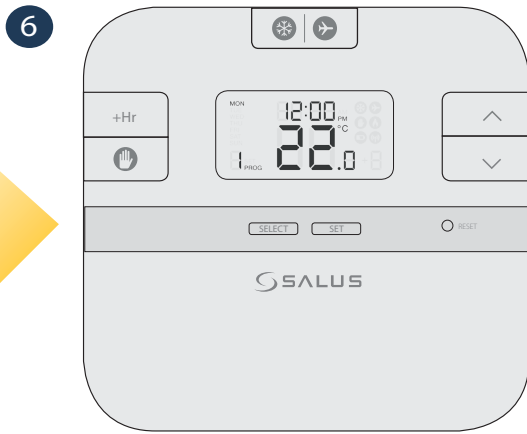

## Holiday Function

Holiday function will turn off the relay, blocking your thermostat from sending any call for heat. If room temperature is lower than the frost setpoint, then Frost Mode will be activated.

Follow the steps below in order to set the Holiday Mode.

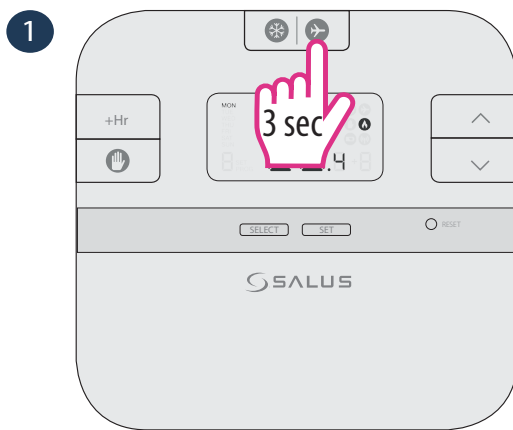

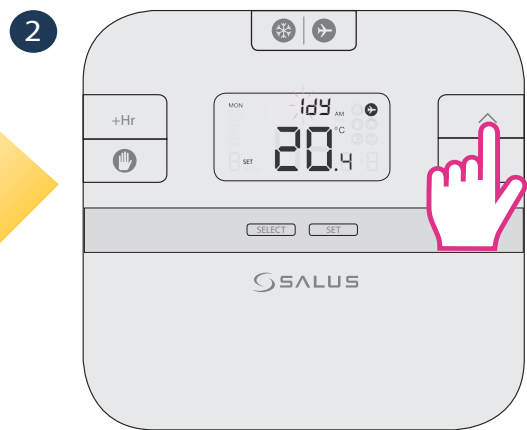

Press the  for 3 sec to turn the Holiday Mode ON.



Press Up/Down to set the Holiday period. \*Max 31 days

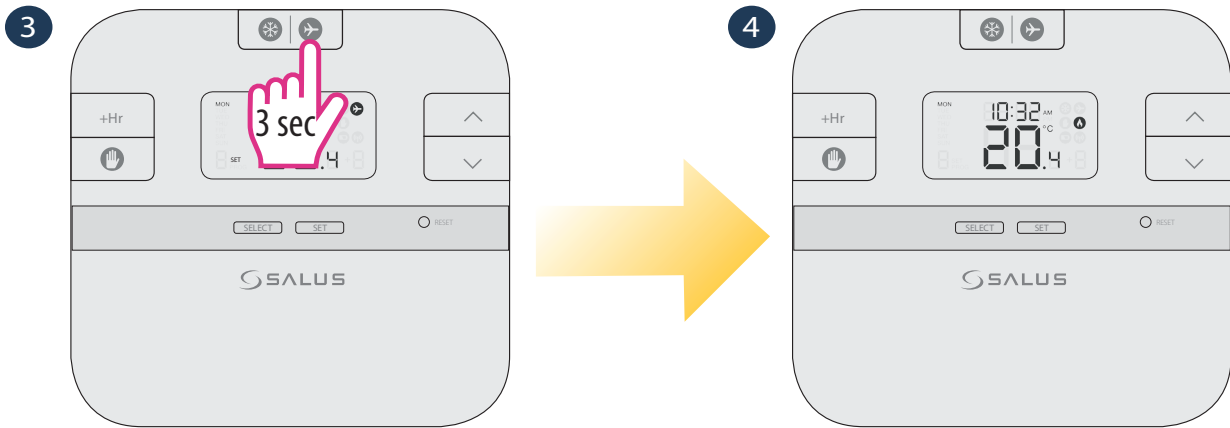



Press the  for 3 sec to turn the Holiday Mode OFF.

**Note:** You can also exit Holiday Mode by setting the day to zero.

## Other Functions

### Backlight

The backlight of the RT510RF is switched on automatically whenever any of the keys are pressed. The backlight will remain illuminated for approximately 5 seconds after the last key press, except if you are changing settings within the Clock, Programme or Temporary Override modes. In this case, the backlight will remain illuminated throughout the setting change process. The backlight will not illuminate if the RT510RF battery is low.

### Battery Status

The RT510RF checks the battery voltage frequently during normal operation. If the battery voltage is sensed as being low (this is normally when the battery voltage falls to a level of around 2.6V), the low battery indicator will be displayed on the screen. You should replace the batteries as soon as possible to prevent any possible operating problems. When you want to change the batteries your device will use the internal memory to backup your settings. You have 30 sec to change the batteries before losing your settings.

### Sleep Mode

By pressing both the UP and DOWN keys together, the RT510RF will enter SLEEP mode. In this mode, all the RT510RF functions will be paused to save battery power, with the exception of the clock which will continue to run in the background.

While in SLEEP mode:

- The LCD display will be blank.
- All output from the Control Unit will be turned off immediately.

Press any key to wake up the RT510RF and cancel SLEEP mode.

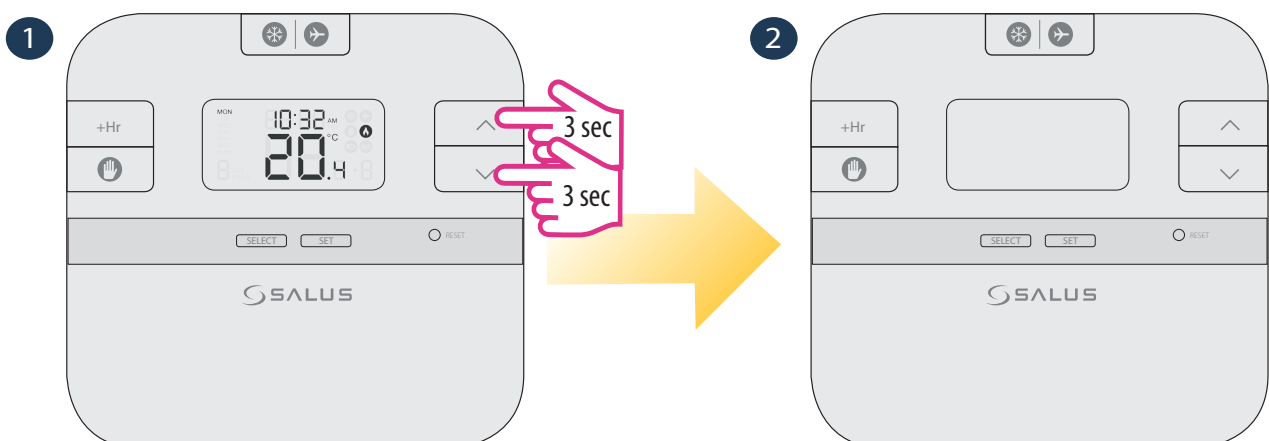

## Reset Function

The Reset Button is provided as a way to restore the programmable thermostat to its default factory settings. Pressing this button will delete any previously entered settings. This should only be done by your installer.

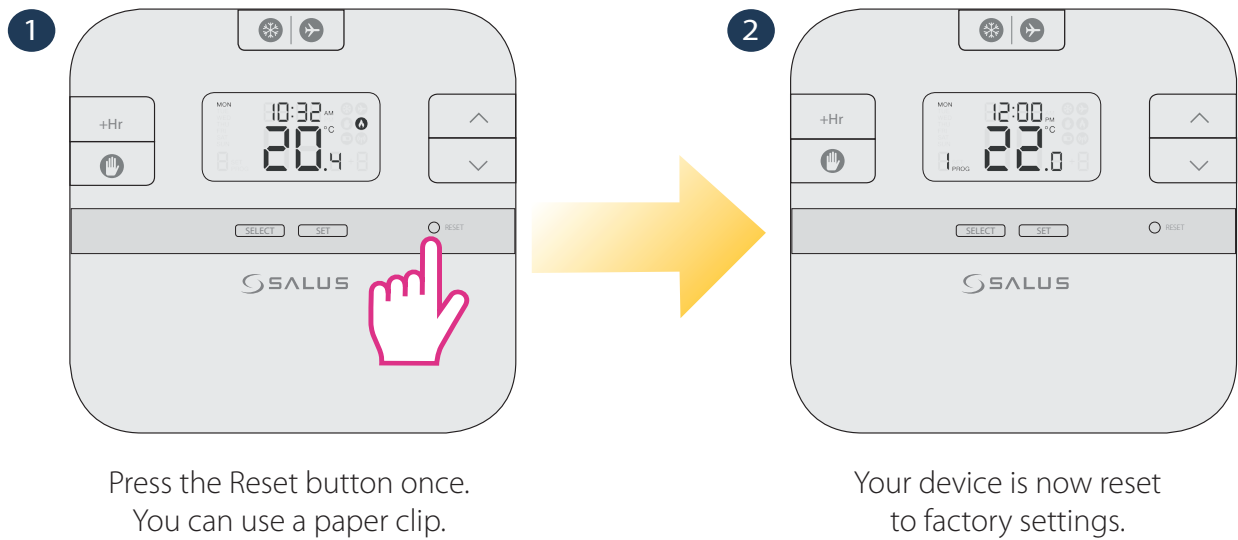

## Technical Information

<b>Model</b>	RT510RF
<b>Type</b>	Electronic programmable thermostat, designed for Volt Free and AC heating applications
<b>Programming Modes</b>	User selectable for 5/2 and Individual day options
<b>Program Number</b>	1-6 Selectable
<b>Modes</b>	Holiday, Boost, Program and Frost
<b>Override</b>	Permanent and temporary
<b>Frost Protection</b>	5°C Adjustable
<b>Power Source</b>	230V AC 50Hz for RXRT510 and 2xAA batteries for RT510TX
<b>Temperature Scale</b>	5 to 35°C
<b>Device Parameters</b>	See page 9
<b>Operating Temperature</b>	0 to 40°C
<b>Storage Temperature</b>	-20 to 60°C

## Warranty

SALUS Controls warrants that this product will be free from any defect in materials or workmanship, and shall perform in accordance with its specification, for a period of two years from the date of installation. SALUS Controls sole liability for breach of this warranty will be (at its option) to repair or replace the defective product.

Customer Name: .....

Customer Address: .....

..... Post Code: .....

Tel No: ..... Email: .....

Company Name: .....

Tel No: ..... Email: .....

Installation Date: .....

Installer Name: .....

Installer Signature: .....

SALUS Controls PLC

SALUS House

Dodworth Business Park South,  
Whinby Road, Dodworth,  
Barnsley S75 3SP, UK.

Sales: T: +44 (0) 1226 323961  
E: sales@salus-tech.com

Technical: T: +44 (0) 1226 323961  
E: tech@salus-tech.com

[www.salus-controls.com](http://www.salus-controls.com)



SALUS Controls is a member of the Computime Group

Maintaining a policy of continuous product development, SALUS Controls plc reserves the right to change specification, design and materials of products listed in this brochure without prior notice.

For the latest PFD Instruction Manual, go to [www.salus-manuals.com](http://www.salus-manuals.com)